



Industrial overhead doors

Tailor made doors - optimised in design and function



Intelligent Door Solutions

Novoferm subsidiaries and sites

- Novoferm production site
- Novoferm sales office

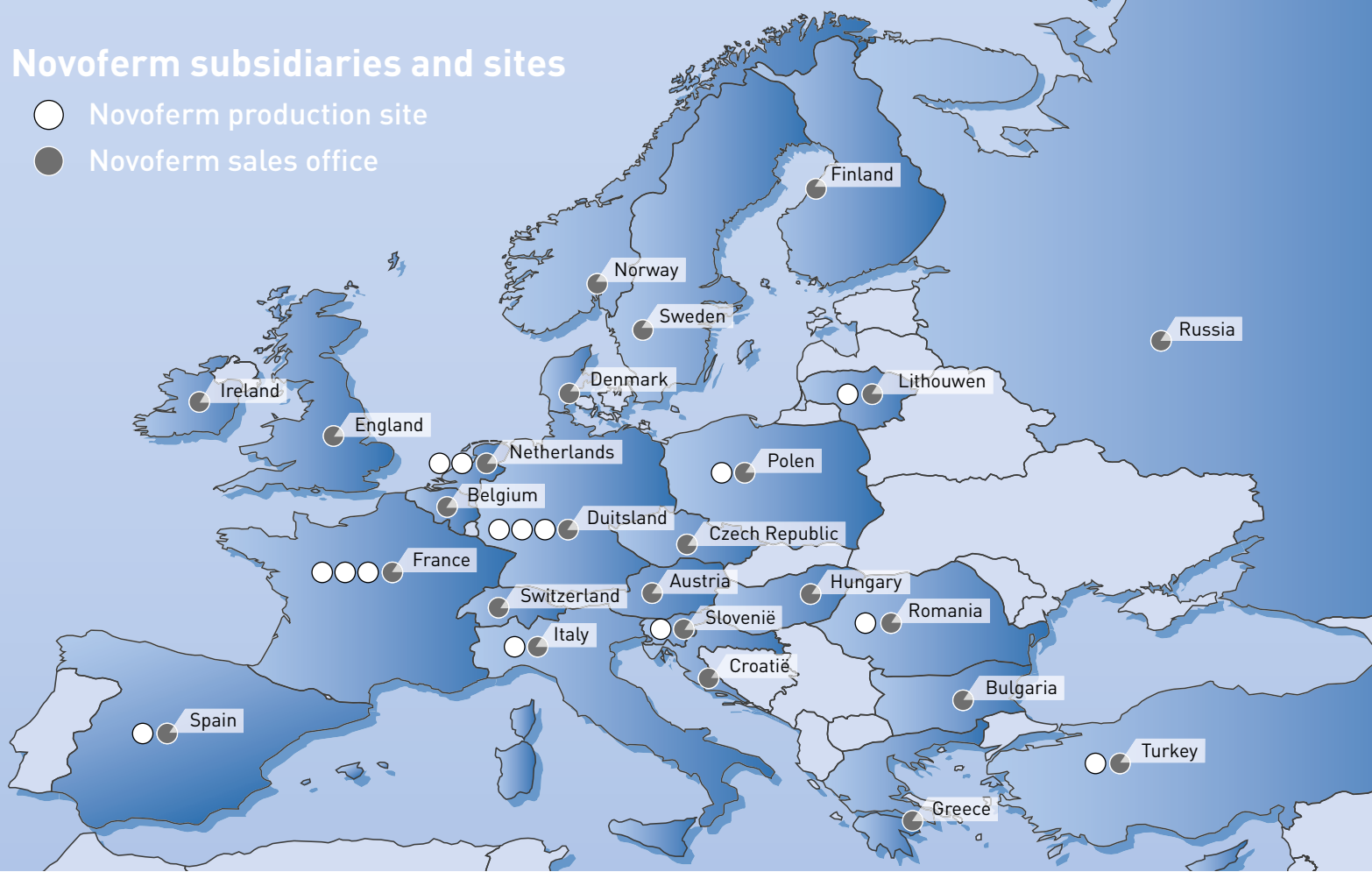

Novoferm international

Novoferm is part of the Sanwa Group. Founded in 1956, now with annual sales in over 60 countries totalling more than € 2 billion and with more than 8,700 employees, Sanwa is the world's largest producer of metal door systems. Sanwa provides everything from: industrial doors, fire protection doors, garage doors, roller shutters and automation. Our products are used around the world in industrial, commercial and residential applications. For over thirty years Novoferm has specialised in many forms of access systems for industrial, commercial and residential buildings.

With a wide choice of different designs, finishes, operation and installation possibilities you get a bespoke solution every time. We take care of the complete process from technical advice to solution development, production, assembly and support on site. All aspects of the project including complete compliance with all relevant standards and legislation are always kept sharply in focus, which saves you a great deal of work. In addition to industrial doors, draught excluding and fire-excluding doors, Novoferm has a full range of Dock Equipment. Our modern dock levellers and shelters guarantee efficient and draught-free loading and unloading of freight vehicles.

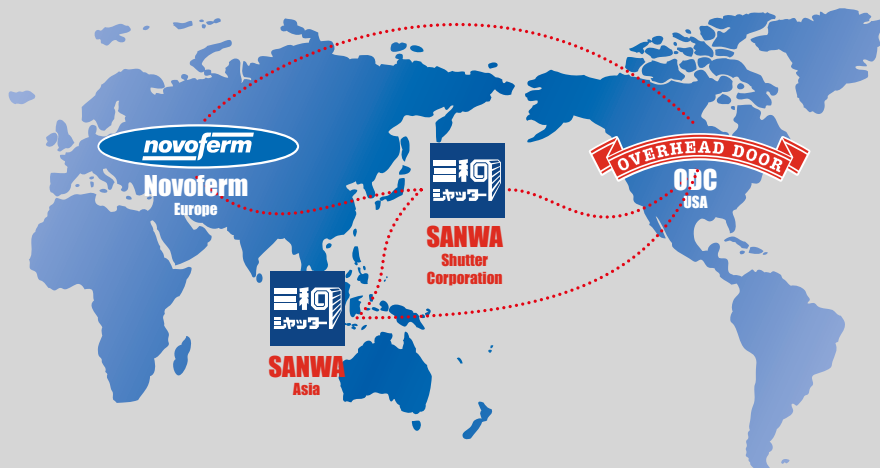



Content

- Novoferm Strong doors everywhere 4
- State-of-the-art production..... 5
- Precision logistics..... 6
- The benchmark for overhead doors 7

- Thermo 40 mm 8
- Thermo 60 mm 10
- Thermo 80 mm 12
- Interior view Thermo 40/60/80 mm 14
- Novoferm’s in-house range..... 16
- Types of windows 17

- NovoLux 40 mm 18
- NovoLux 60 mm 20
- NovoLux XL 40/60 mm..... 22
- Interior view NovoLux 40 / 60 mm 24
- NovoLux 40 mm/60 mm window frames.... 26

- Track-systems..... 28
- Interior view..... 30
- Overview of rail systems..... 32
- Power..... 34
- Control box features 36
- Extra control features..... 38
- Mechanical safety devices 40
- Electronic safety devices 42

- Wicket- and Side-doors 40/60 mm..... 44
- Permanent wicket door next to the overhead door 46
- Wicket door built into the overhead door 48
- Integrated wicket door as an emergency exit..... 50
- Wicket door accessories and options 52

- NovoSpeed Thermo 54
- Technical details 56
- Notes 58
- Other Novoferm products..... 60

Novoferm, Strong doors everywhere

Distinctive, dependable, durable

Our doors are open for you

Novoferm industrial overhead doors have provided solutions for hundreds of thousands of projects, ever since we first began production. A Novoferm door stands out from all other doors- through its design, operation, detailing and versatility. Novoferm doors are distinctive, robust and reliable.



Quality in every detail

At Novoferm we don't think in terms of doors, but in terms of solutions. It is your specific requirements and wishes that are at the forefront of the design and manufacturing process, resulting in doors characterized by their quality and individuality, right down to the smallest detail. These are the doors the market demands and that can be found in any sector and building. In fact, wherever you go you're likely to run into a Novoferm door.

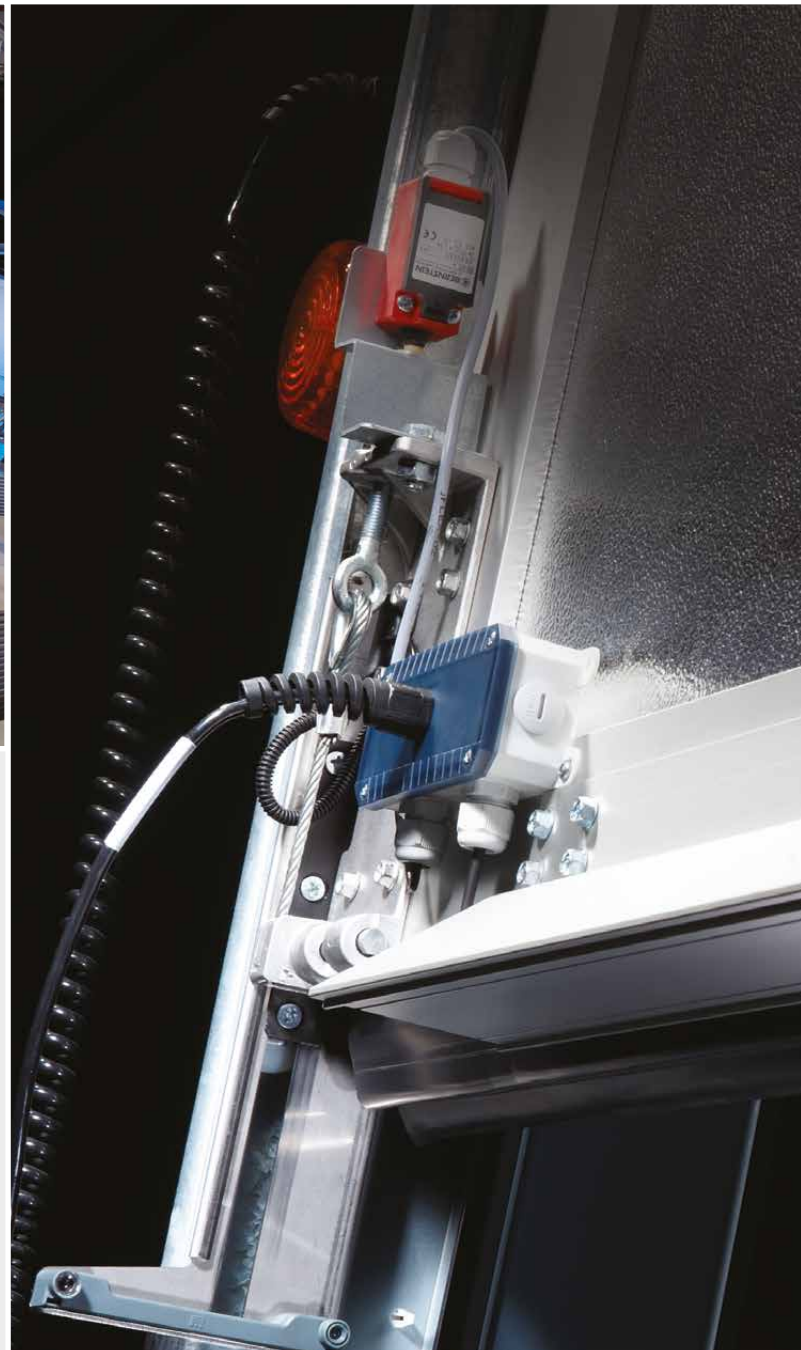

State-of-the-art production

Innovative trendsetters

Everything under one roof

Novoferm produces everything in-house and in accordance with strict European laws, rules and standards. This is our guarantee to you that an Novoferm door meets the highest possible requirements. We also have strategic alliances with top manufacturers, allowing us to offer a complete range of industrial and garage doors, all under a single and trusted roof. We purchase parts and components from worldwide preferred suppliers, which means Novoferm can guarantee a level of quality that is unique in our industry.

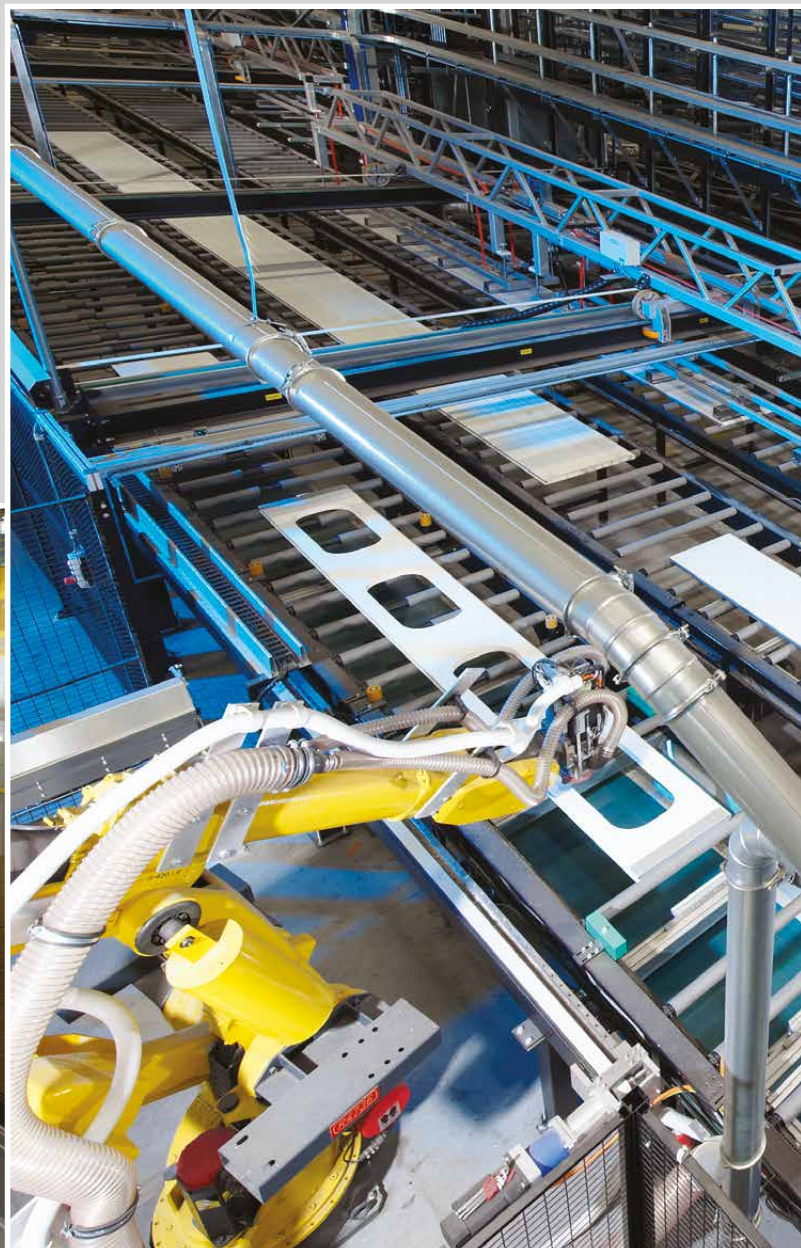

From production to delivery

Our door panels and rail systems are tailor-made according to order using the automated production processes in our state-of-the-art production facilities. We build the necessary suspension packages in our own factory, with the separate parts manufactured using specialist tools of our expert suppliers. All components that are part of the package are collected at a pre-programmed location in our warehouse, ready for shipment to any location you wish.

Smarter and better

Novoferm aspires to be a trendsetter and so the company continually invests in people, material and means. At the same time, we realise that when purchasing industrial doors our client's main concern often is the price. But that does not mean we have to compromise on quality. We focus all our attention on creating even smarter and better production methods. This is the only way we can continue to market high-quality precision products at extremely competitive prices.

Precision logistics

Service-oriented and cost-saving

Just in time, wherever you want

Novoferm does not just develop and manufacture, we also take care of everything for our clients, from logistics and assembly to service. In order to provide full support to you 24 hours a day, we have dedicated sales regions. You are always welcome to call on any of these centres for tailor-made advice and any questions you might have. Our contact details are listed on the back of this brochure.



Doorcalculation

The Novoferm Doorcalculation program provides the Novoferm dealer access to a very useful and user friendly calculation system. Through this system our dealers can prepare and calculate various complete projects. The system is constructed and build up with different product groups. Thermo, NovoLux and Panorama overhead Doors in 40 mm and 60 mm thickness, Roller and fast action Roller Doors, Garage Doors, Levellers and Shelters (Docking Equipment) The output from our calculation system generates offers and detailed project descriptions ready to be sent to their client and dealer corporate identity is also an option. Novoferm offers further professional service as the client specific conditions are set within the system and at any given time the price is shown.

The benchmark for overhead doors

Intensively tested and checked

Safety certified

Novoferm products are subject to constant and intensive durability tests. In these tests, the prototypes open and close 30,000 times, after which they are assessed by experts. This constant attention to quality and safety has paid off: our overhead doors and their physical qualities are fully EN13241 compliant and are all TÜV Nord certified.

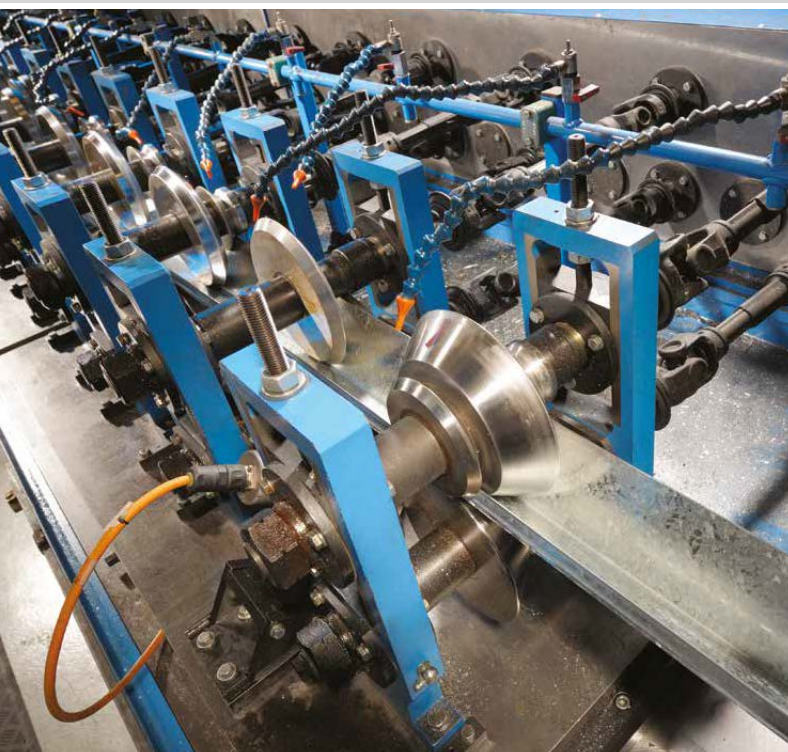
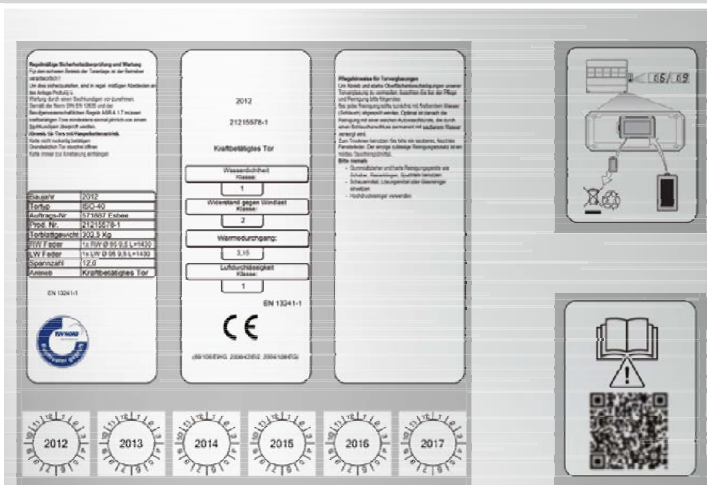





Physical qualities

Numerous mechanical and electronic qualities of the Novoferm overhead doors are checked during the thorough tests. These tests, performed by TÜV Nord, the stringent German certification and inspection body, mean that each tested physical quality receives its own classification, making it easier to compare similar products from different manufacturers.

Assessment criteria

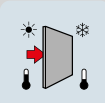
Novoferm overhead doors are tested for:

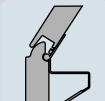
-  Resistance and wind load
-  Sound absorption
-  Waterproofness
-  Heat insulation
-  Air permeability
-  User safety



Thermo 40 mm



Novoferm's all-rounder

The Thermo 40 mm overhead door is Novoferm's most popular door, a modern design that unifies excellent thermal insulation and sound absorbing qualities in its micro-profiled panels.

The choice of design and materials are endless, which means the door can always be perfectly configured to meet your wishes. Numerous types of built-in windows as well as different heights and widths make up the Thermo 40 mm range, as well as a variety of 13 standard Novoferm's in-house RAL colours.

Flexibility is everything

Thermo 40 mm overhead doors are designed and manufactured using the very latest technology. Their finish is robust and detailed, as demonstrated by the metal or aluminium end caps, the reinforcement profiles and the anodized aluminium sub-profiles, which cannot be seen from the outside. Flexibility is everything in the manufacturing process, and it is a true all-rounder that perfectly combines price, performance and application options.



Sandwich-construction Thermo 40 mm panel

Panel thickness:	40 mm
Thermal conductivity:	$\lambda=0.025 \text{ W/mK}$
Insulation value:	$U=0.52 \text{ W/m}^2\text{K}$
Density PU foam:	40 kg/m^3

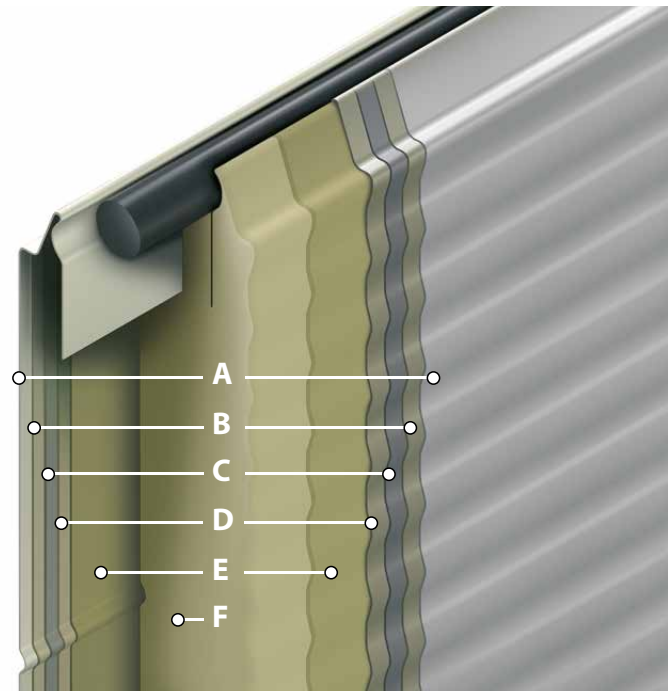

A Paint layer:	13 standard colours (outside)
B Zinc coating:	275 g/m^2
C Steel sheet:	0.5 mm
D Zinc coating:	275 g/m^2
E Primer coating	
F PU high density foam:	$g=40 \text{ kg/m}^3$, and HCFC-free
E Primer coating	
D Zinc coating:	275 g/m^2
C Steel sheet	0.5 mm
B Zinc coating:	275 g/m^2
A Paint layer:	RAL 9002 (inside)



U-value Thermo 40 mm overhead door:
5,000 x 5,000 mm: $1.19 \text{ W/m}^2\text{K}$

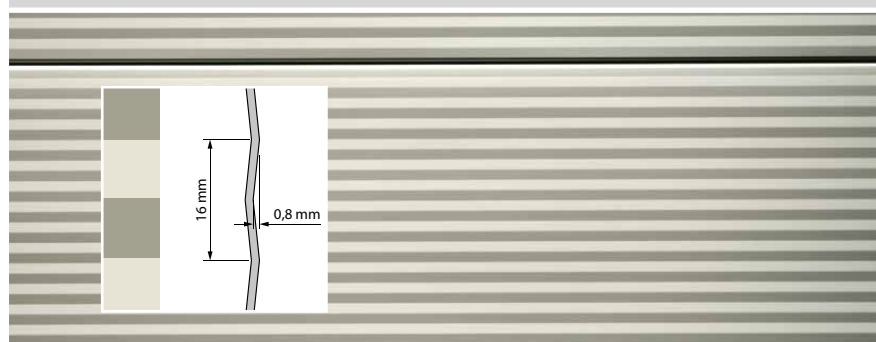

Micro-profiling, it's the standard!
13 Standard colours without any extra charge

Thermo 60 mm

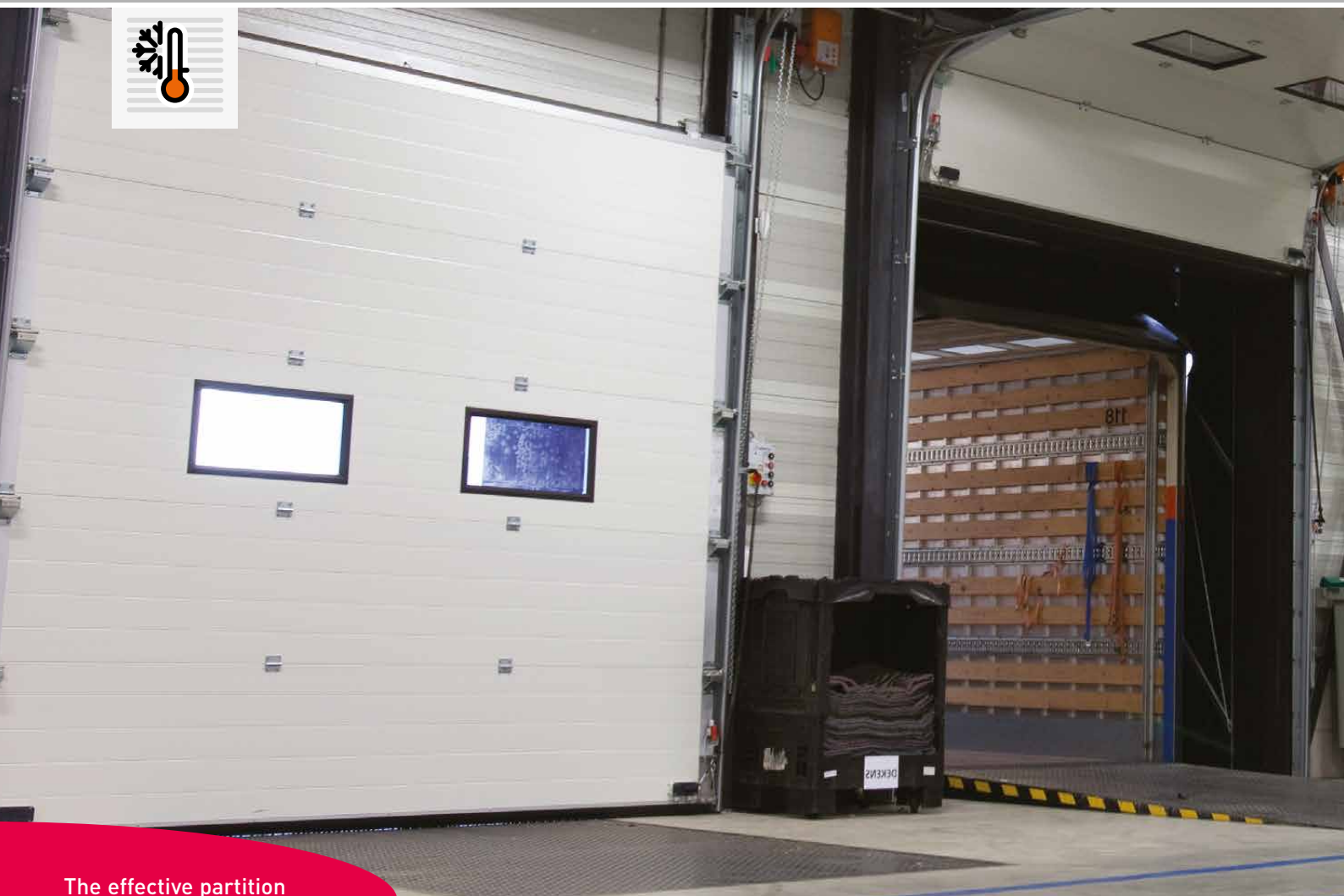
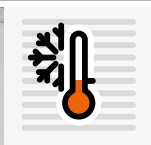

The effective partition between climate zones

Thermo 60 mm overhead doors are overhead doors with extra-insulating and sealing properties that are mainly used in locations where the division between different climate zones is important.

If you need to keep your production hall or storage area at a constant temperature, the Thermo 60 mm door is the right one for you. The micro-profiled steel plate panels have excellent sound-absorbing and heat-insulating properties and they can withstand all the elements.

Very high insulative value

The panels of the Thermo overhead doors are manufactured using what is known as the sandwich method, a process that entails a layer of CFC-free rigid polyurethane foam being inserted between two zinc-coated steel plate sheets and glued in place. The doors are available in 10 standard colours. The steel plate sheets can also be spray painted in a RAL colour of your choosing.



Sandwich-construction Thermo 60 mm panel

Panel thickness: **60 mm**
 Thermal conductivity: **$\lambda=0.025 \text{ W/mK}$**
 Insulation value: **$U=0.35 \text{ W/m}^2\text{K}$**
 Density PU foam: **40 kg/m^3**

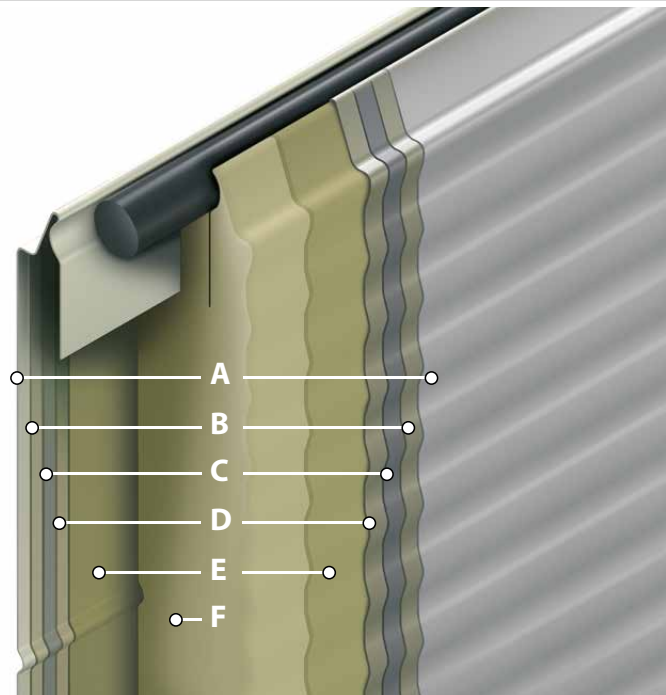

A Paint layer: 10 standard colours (outside)
B Zinc coating: 275 g/m^2
C Steel sheet: 0.5 mm
D Zinc coating: 275 g/m^2
E Primer coating
F PU high density foam: $g=40 \text{ kg/m}^3$, and HCFC-free
E Primer coating
D Zinc coating: 275 g/m^2
C Steel sheet: 0.5 mm
B Zinc coating: 275 g/m^2
A Paint layer: RAL 9002 (inside)

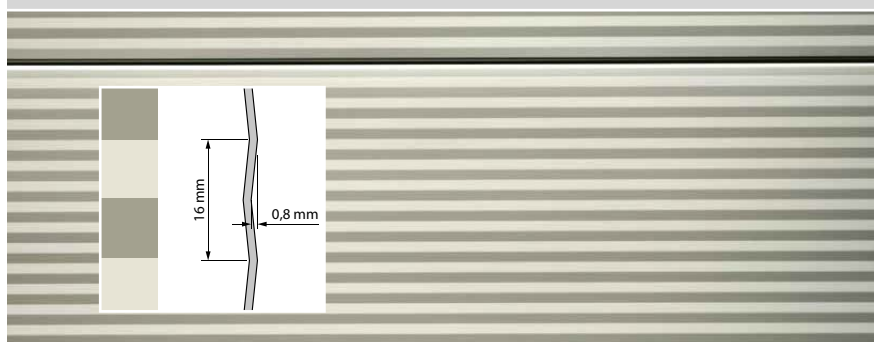

U-value Thermo 60 mm overhead door:
 5,000 x 5,000 mm: $0.95 \text{ W/m}^2\text{K}$

Micro-profiling, it's the standard!
 10 Standard RAL colours without any extra charge.

Thermo 80 mm



75

76

NEW!

Thermo 80 mm

Double-skinned overhead doors with thermally broken steel panels.

Commercial buildings need to satisfy increasingly higher levels of insulation performance. Standards are being made more demanding and this trend will continue. All areas of the building need to be brought in line with these requirements, including the entrances. Like the Thermo 40 mm and Thermo 60 mm overhead doors, the panel cavity is filled with dense polyurethane foam, with a thermal break between the inner and outer skins. The Thermo 80 mm overhead door uses the same design principle but offers even greater thermal insulation. By offering optimum

insulation performance coupled with a U value of $0.25 \text{ W/m}^2\text{K}$, the Thermo 80 mm satisfies the requirements of customers who want to construct buildings (or have them constructed) in accordance with today's standards. As a result, this door is ideal for cold stores and refrigerated warehouses, industrial buildings, warehouses and distribution centres where heat loss is a major risk and/or where the temperature of the goods must be guaranteed. The Thermo 80 mm overhead door is available in RAL 9002, RAL 9006 or RAL 7016.

Windows

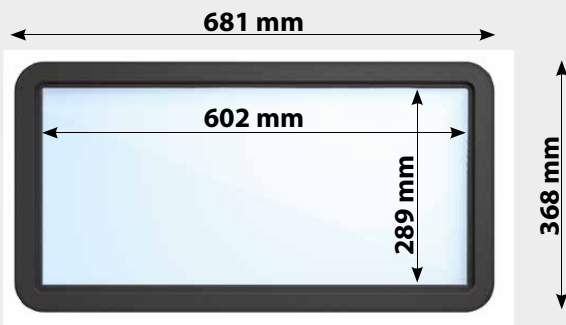

The Thermo 80 mm door can be fitted with new designed windows with straight corners, for increased natural light. Combined with the elegant Microline profiling it provides an attractive appearance.

Colours



The Thermo 80 mm overhead door is available in RAL 9002, RAL 9006 or RAL 7016. Do you have special requirements when it comes to the colour? Novoferm offers a whole rainbow of colours.

Sandwich-construction Thermo 80 mm panel

Panel thickness: **80 mm**
 Insulation value: **$U=0,25 \text{ W/m}^2\text{K}$**
 Density PU foam: **40 kg/m^3**
 Density PU foam: Outside Microline profiling
 Inside stucco design

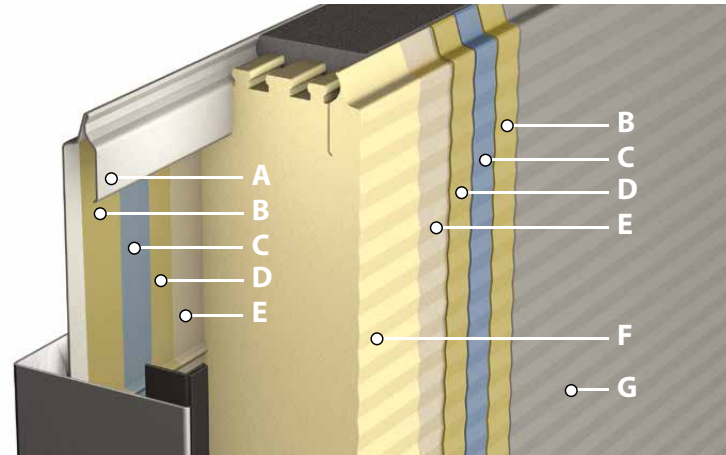

- A** Paint layer (outside): RAL 9002, RAL 9006, RAL 7016
- B** Zinc coating: 275 g/m^2
- C** Steel sheet: 0,5 mm
- D** Zinc coating: 275 g/m^2
- E** Primer coating
- F** PU high density foam: $\rho=40 \text{ kg/m}^3$, CFK and H-CFK -free
- G** Paint layer (inside): RAL 9002



Floor seal

For optimal floor sealing, Novoferm uses a double rubber bottom seal with inward bend edges. This unique bottom seal with its special profile ensures very low thermal conductivity.

Insulation value

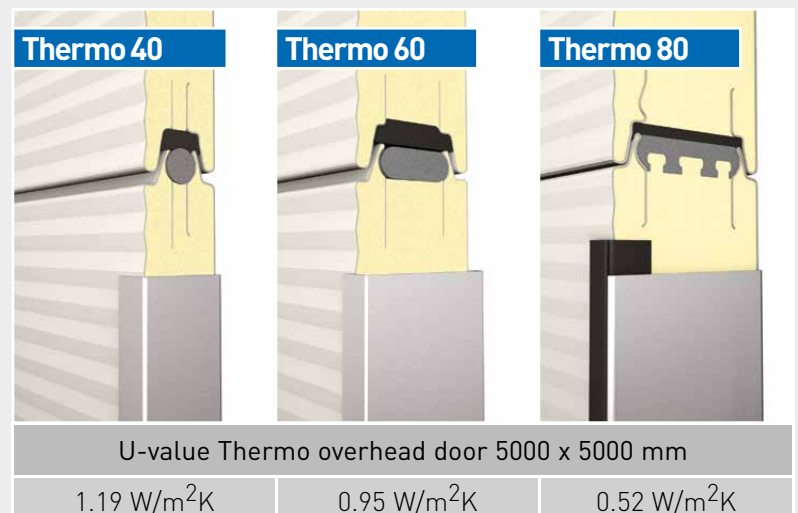

Panel seal

The panels of the Thermo 80 mm door are specially sealed to make them completely wind and waterproof using Compriband, a polyurethane sealing strip that is attached between the panels. Additionally, the Thermo 80 mm doors are fully insulated, because the inner and outer door panels are not attached to each other.

Interior view Thermo 40/60/80 mm



The interior

The interior of the ISO 40 mm and ISO 60 mm overhead door is horizontally profiled, the ISO 80 overhead door is stucco profiled and is coated in RAL 9002 as a standard. Other colours are available on request at an additional cost.

1

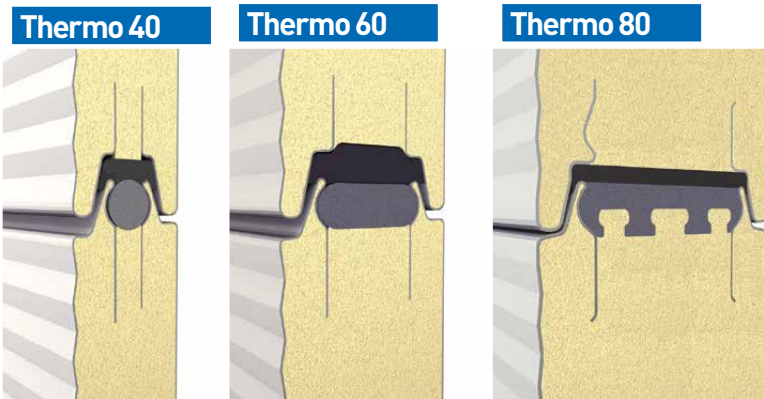

Panel seal

The panels of the Thermo 40/60/80 door are specially sealed to make them completely wind and waterproof using Compriband, a polyurethane sealing strip that is attached between the panels. Additionally, the Thermo 40/60 doors are fully insulated, because the inner and outer door panels are not attached to each other.

2

Thermo 40/60

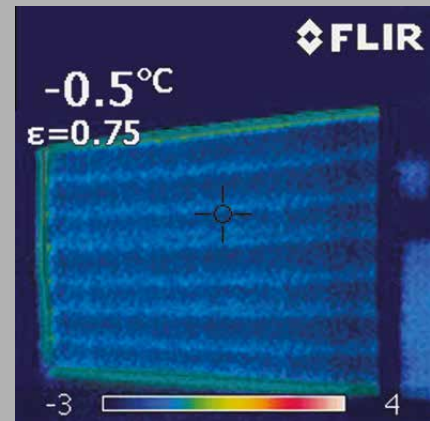

Infrared imaging

The Thermo 60 mm and 80 mm overhead door insulates even more effectively than the Thermo 40 mm door. We check this feature by taking infrared images of the assembled doors. Any light spots indicate where energy loss occurs, while the dark regions are well-insulated.

3

Thermo 40/60/80



Standard frame

The standard frame between the door and the vertical railing ensures that the sides of the door seal properly.

3

Thermo 40/60/80



Heavy-duty frame

We use this type of frame for doors with a dark colour. Due to the heat of the sun, the door may expand in the middle against the upper lintel. The heavy-duty frame prevents this from happening.

4

Thermo 40/60



Wind load

Depending on the width of the door, Novoferm will install reinforcing profiles on the door. Thanks to these, the door is able to withstand a heavy wind load, in accordance with the applicable rules and standards.

5

Thermo 40/60



The interior

The interior of the Thermo 40 mm and Thermo 60 mm overhead door is horizontally profiled and is coated in RAL 9002 as a standard. Other colours are available on request at an additional cost.

Novoferm's in-house range

Novoferm provides 13 standard colours (no extra charge)

Thanks to Novoferm, architects can now indulge in design and colour variations. The optical properties of the microprofiled sheet plate makes the doors perfectly suited to modern industrial architecture. Novoferm's in-house range offers 13 common RAL colours to give each door its very own personality—at no extra cost. Thanks to this selection of colourfast coil coatings, the doors can always be seamlessly integrated into your company's look.

Do you have special requirements when it comes to the colour? Novoferm can offer you a whole rainbow of colours.



Dark colors are to be avoided with double-walled steel doors situated in full sunlight, as a possible deflection could damage the door.



New: RAL 7021



RAL 3000



RAL 5003



RAL 5010



RAL 6009

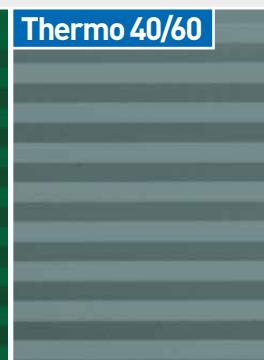

RAL 7005

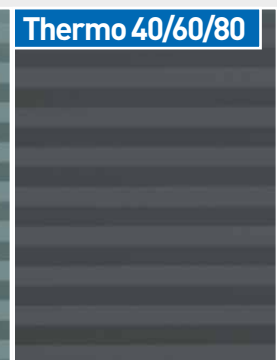

RAL 7016



RAL 8014

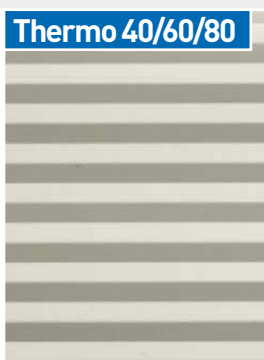

RAL 9002

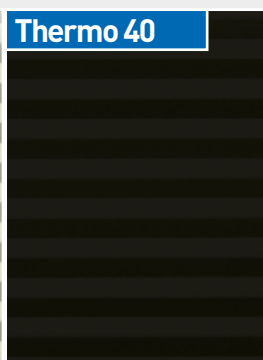

RAL 9005



RAL 9006

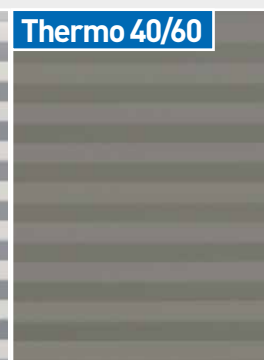

RAL 9007

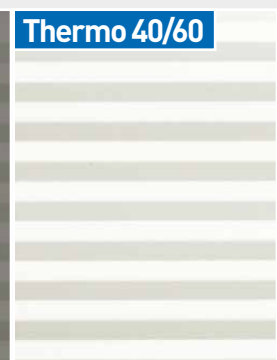

RAL 9010

Types of windows

The purpose of windows

Thermo overhead doors can be fitted with Plexiglas windows for increased natural light and improved visibility. The standard windows are oblong, with straight or rounded corners containing single or insulating double glazing.

For additional security against intruders, narrow rectangular windows with rounded corners are also available. Are you looking for a one-of-a-kind design? Then go for the rounded windows or a creative pattern made up of windows.



☀️ The light yield of the various windows



Lots of light and great visibility



Rounded corners (r=60 mm), excellent insulation value

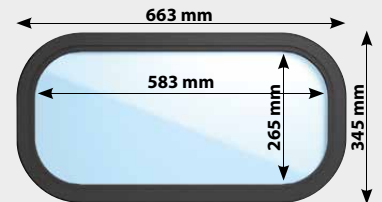

Rounded corners (r=100 mm), excellent insulation value

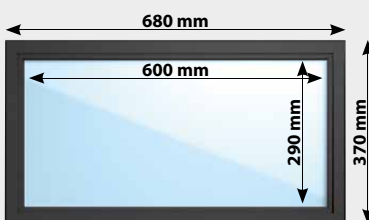

Straight corners, excellent insulation value

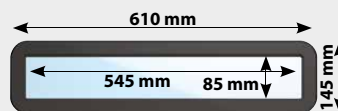

Narrow, burglar-proof windows



Attractive round windows



When natural light and visibility matter

In industrial environments, where light and visibility are of paramount importance, the Novoferm NovoLux 40 mm overhead door proves to be indispensable. The door panel of an NovoLux door consists of multiple sections, and thanks to the custom-sized aluminium profiles, frames can be manufactured that have a very wide range of uses. Be bold and combine transparent, coloured, insulating or air-permeable windows with aluminium cassette panels. Anything is possible.

Be adventurous with windows

NovoLux 40 mm overhead doors can be equipped with plastic window frames of various quality levels and with different insulation values, colours or filling materials. Go for coloured glass or hollow-core plates, play with the divisions or combine various Thermo panels with the NovoLux sections for a great result. Thanks to the plethora of design and application options, the NovoLux 40 mm overhead door is particularly useful if you want to combine an attractive design with optimal light transmittance.

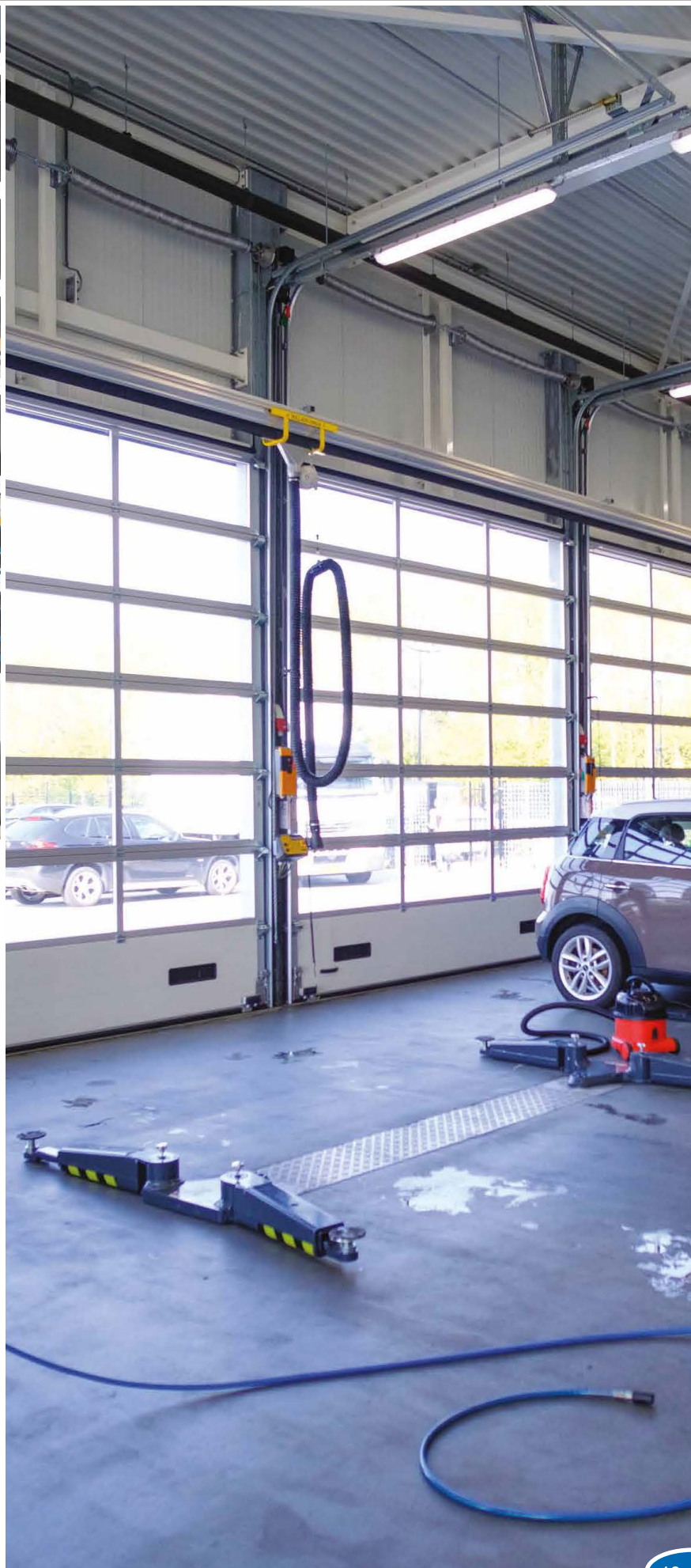

U-value of NovoLux 40 mm overhead door:
5,000 x 5,000 mm: 3.87 W/m²K



The innovative door with even more insulation

The NovoLux 60 mm overhead door is a modern innovation that excels in terms of design, functionality and ease of assembly. The 60 mm thick NovoLux overhead door comes with triple glazing and guarantees excellent heat-insulating, anti-condensation and sound-absorbing properties. It's the perfect solution for rooms where light, visibility and a constant indoor climate are essential.

Special insulation profiles

The NovoLux 60 mm door is twice as thick as the NovoLux 40 mm door and consists of two aluminium profiles that are thermally separated by special insulation profiles. The door has an extremely low U-value, even though it is fitted with glazing. The NovoLux 60 mm overhead door is particularly suited to industrial facilities where illumination is of the utmost importance, as are excellent insulation and optimal energy savings.



U-value NovoLux 60 mm overhead door:
5,000 x 5,000 mm: 2.38 W/m²K, with triple glazing

NovoLux XL door 40/60 mm



Maximum transparency,
Without vertical profiles

The NovoLux XL door is a NovoLux overhead door available in 40 mm or 60 mm versions. What makes this door unique is that the panels **do not have vertical dividers**, providing a wide panoramic view. The high-quality Plexiglas is extra thick and extra strong, hardly distorts and it looks just like real glass. All these features result in the windows being naturally reflective and looking highly attractive.

Plexiglas Optical

The NovoLux XL door is available in a maximum width of 4,000 mm and a maximum height of 4,500 mm. The NovoLux XL doors look particularly good in buildings that are designed to be appealing, but where light and visibility are just as important. The special thing about the high-quality Plexiglas Optical is that it looks just like real glass but has the added safety of plastic. The Plexiglas Optical windows are available in 20 mm double glazing and in 40 mm triple glazing.



Highest scratch-resistance
 - Therefore that you do not lose the vista



NovoLux XL door 40 mm

Double Plexiglas
 Optical 20 mm
 (4-12-4 mm)

NovoLux XL door 60 mm

Triple Plexiglas
 Optical 40 mm
 (4-14.75-2.5-14.75-4 mm)

U-value of:
 the NovoLux XL door 40: 4,000 x 4,000 mm: 3.87 W/m²K
 the NovoLux XL doorr 60: 4,000 x 4,000 mm: 2.36 W/m²K

Interior view NovoLux 40 / 60 mm





Section connection
 The sections of a NovoLux 40 door are specially sealed to make them completely wind and waterproof using an EPDM rubber door seal.



Aluminium glazing beads
 Aluminium glazing beads stay perfectly sealed and retain their high-quality appearance, even in wide temperature fluctuations.



Triple synthetic glazing
 The NovoLux 60 door is fitted with triple glazing as standard for additional insulation. The windows are fitted in thermally separated insulation profiles. Double synthetic glazing is also available, although that means the insulative value will be lower.



Condensation
 Condensation will soon appear on the inside of a standard NovoLux 40 door at low outdoor temperatures and a high indoor atmospheric humidity. This is because condensation forms on the coldest surface in the room, which is the door. If you wish to stop condensation forming on your doors, the NovoLux 60 door is the one for you. Condensation will never be an issue – even if indoor humidity levels are high – thanks to the fact that the door is equipped with special insulation profiles.



Wind load
 Depending on the width, the NovoLux overhead door is fitted with integrated single-piece reinforcement profiles. Thanks to the reinforcement profiles, the door is able to withstand a heavy wind load. Depending on the door configuration chosen, we use thicker and/or longer profiles. For a door of 4,200 mm and wider, every other panel has a profile, while for a door of 5,000 mm and wider, each section has a reinforcement profile.

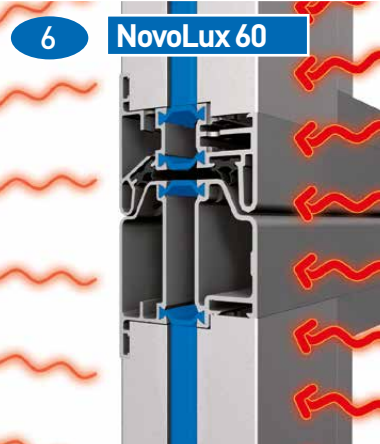

Section seals
 The sections of the NovoLux 60 door are specially sealed to make them completely wind and waterproof. Any heat transmission is prevented by the special insulation profiles.

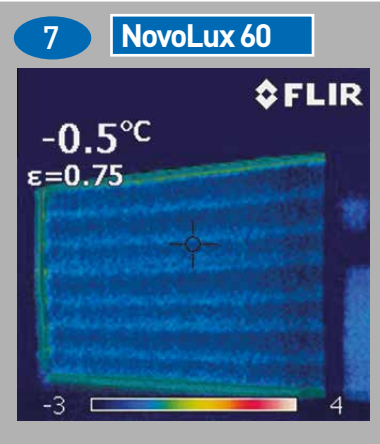

Infrared imaging
 The sections of the NovoLux 60 overhead door are specially sealed to make them completely wind and waterproof. Any heat transmission is prevented by the special insulation profiles.

Aluminium glazing beads

Novoferm is one of the few companies to always use anodised aluminium glazing beads. You will often see windows fixed in place using a black plastic bead, which is not only less attractive and less durable, but also has a different coefficient of expansion than aluminium. If it is warm outside, the plastic is more likely to expand, resulting in bulging glazing beads, which will not happen with our aluminium glazing beads. Another advantage is that our glazing beads are available in any colour you wish.

Different options

Novoferm offers limitless choices in glazing for NovoLux doors. Windows of various levels of quality, colours, degrees of transparency and styles are available, giving architects all the room they need to get creative with the design of your NovoLux doors. Choose from single-plate acrylic or 4 mm tempered glass, double-plate acrylic windows or structural glass, or from perforated single panels or high-impact plastic. The possibilities are endless.



Combining colours

The standard NovoLux door comes in white anodised aluminium. This does not mean that there are no alternative colour options. We can spray-paint the aluminium in any colour you wish. And by combining the aluminium with Rodeca glazing or Thermo panels in one of the 10 colours from Novoferm's in-house range, the design options are limitless.



NovoLux 40



NovoLux 60

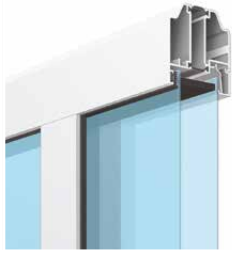

NovoLux 60



NovoLux 80

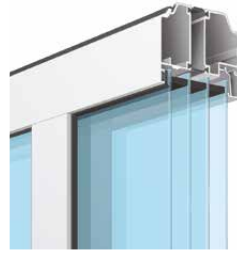

NovoLux 40



NovoLux 60

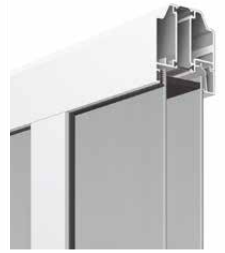

Double-glazed transparent plate
(20 mm) in: acrylic, polycarbonate, Plexiglas Optical (light transmittance 100%)
(40 mm) in: acrylic, polycarbonate, Plexiglas Optical (light transmittance 100%)

Triple glazing transparent plate
(40 mm) in: Plexiglas Optical (light transmittance 100%)

quadruple glazing transparent plate
(60 mm) in: Plexiglas Optical (transparence 100 %)

Double-glazed partially transparent plate
(20 mm) in: structural glass (SAN) (light transmittance 80%)
(40 mm) in: structural glass (SAN) (light transmittance 80%)

NovoLux 40



NovoLux 40



5-core polycarbonate hollow-core plate
(20 mm) transparent (light transmittance 63%)
(20 mm) grey (light transmittance 42%)



NovoLux 40



NovoLux 40

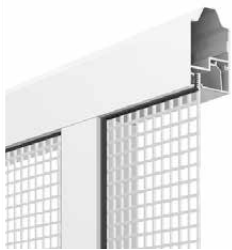

Single-walled perforated NovoLux plate
(2 mm) round perforation (air transmittance 40%)
(2 mm) square perforation (air transmittance 70%)

NovoLux 40



NovoLux 60



Double-wall closed sandwich version
(20 mm) smooth plate on the outside and plaster on the inside
(40 mm) smooth plate on the outside and plaster on the inside

NovoLux 40



NovoLux 60



Double-wall closed sandwich version
(20 mm) plaster on the inside and outside
(40 mm) plaster on the inside and outside

High-quality modular ease of assembly

Novoferm rail systems are modular and largely pre-assembled. The rail systems can be used for both Thermo and NovoLux doors, such as the NovoLux XL door. Certified quality and durability are at the forefront of the design and assembly of our rail systems and suspension packages.



1



Spring buffer

The sturdily-built spring buffer ensures that the door will lower as soon as it is prompted to do so. The length of the spring buffer depends on the door configuration.

2



Floor plate

The floor plate ensures that the rail connects to the floor and, together with the expansion joint profile, sets the correct distance between the guides.

2



M8 bolts

We always use M8 bolts to join the sheet metal sections and rail profiles. That means that, together with the carefully pre-assembled components, assembly time is very short.

4



Cable position

Thanks to the modular structure of our railsystems and sheet metal components, we can ensure the perfect cable position in relation to the vertical rails, which results in optimal safety and reliability.

5



Safety tracks

The safety guide guarantees that the rollers do not become derailed. The cable is safely encapsulated in the construction as an additional safety measure.



Floor seal

Novoferm uses double rubber sealing strips to ensure that the door is flush with the floor. Together with a concrete strip, this will prevent water from seeping under the door.



1

NovoLux 40



1

NovoLux 60



2

NovoLux 40/60



2

NovoLux 40/60

Top seal

The upper door panel of the NovoLux 40 door is equipped with a rubber door seal, which provides additional insulation and ensures the best possible connection to the upper lintel. The door fits seamlessly and no energy is lost.

The upper door panel of the NovoLux 60 door is equipped with a rubber door seal, which provides additional insulation and ensures the best possible connection to the upper lintel. The door fits seamlessly and no energy is lost.

Single side hinge

Novoferm uses single side hinges for doors that open up to 5 meters. They are sturdily built and ensure that the door hangs well and closes properly.

Double side hinge

Novoferm uses double side hinges for doors that open more than 5 meters. This ensures that even the heaviest of doors hang well.

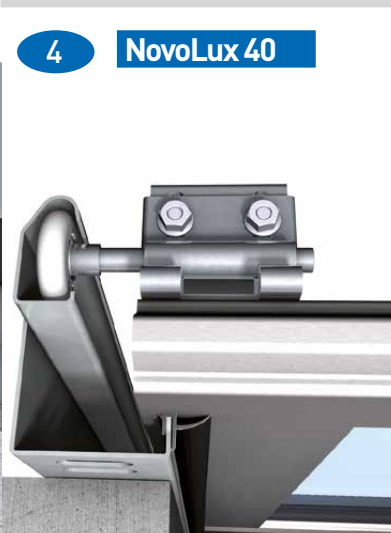

4

NovoLux 40



4

NovoLux 60



4

NovoLux 40



4

NovoLux 60

Standard frame

The standard frame between the door and the vertical railing ensures that the sides of the door seal properly.

Heavy-duty frame

We use this type of frame for doors with a dark colour. Due to the heat of the sun, the door may expand in the middle against the upper lintel. The heavy-duty frame prevents this from happening.

Overview of rail systems

The available space for the door and the local structural issues remain deciding factors when it comes to installing a door, which is why Novoferm offers different rail systems that can be customised to suit any scenario.

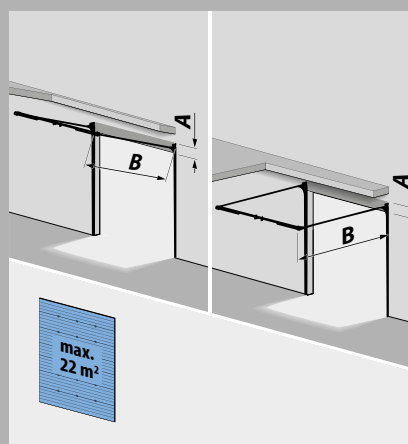

**T 240 (B24),
low built-in rail system,
incorporated cables +
steel support profile**

A= 240 mm,
B= open height + 1,000 mm
Width max. 6,500 mm

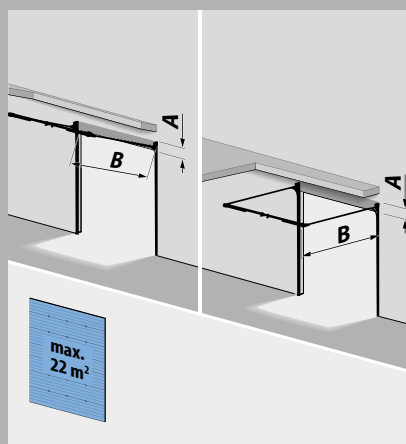

**T 340 (B34),
standard rail system,
rear suspension package
+ steel support profile**

A= 340 mm,
B= open width + 750 mm
Width max. 4,500 mm

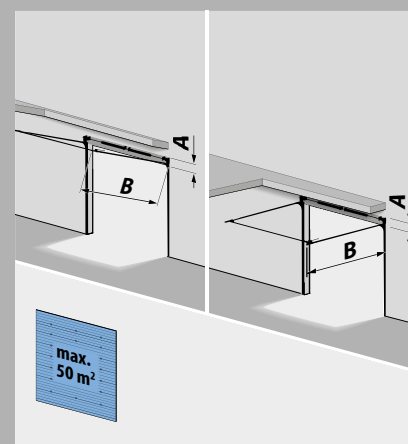

**T 450 (B45),
standard rail system
(comes standard)**

A= 430-510 mm,
B= open height + 650 mm

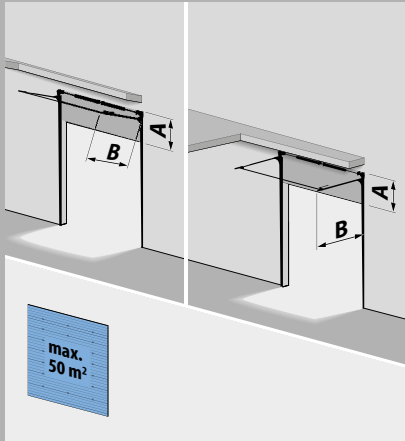

**T 400 (B350),
elevated rail system**

A= hoisting + 400 mm,
B= open height - hoisting + 600 mm

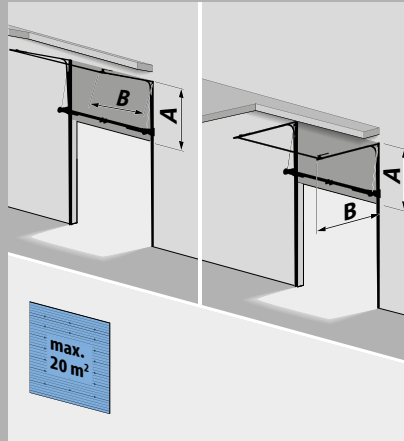

**T 400 hF (B350),
elevated rail system
with low spring axis +
steel support profile**

A= hoisting + 200 mm,
B= open height - hoisting + 600 mm
Width max. 4,500 mm
Lift min. 1,450 mm

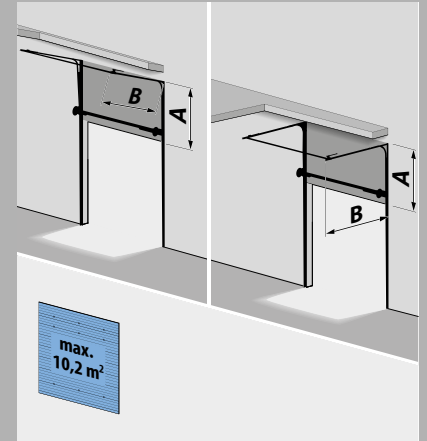

**T 400 DS (B350 dock),
elevated rail system
with low spring axis**

A= hoisting + 200 mm,
B= open height - hoisting + 600 mm
Width max. 3,200 mm
Height max. 3,200 mm
Lift min. 1,700 mm

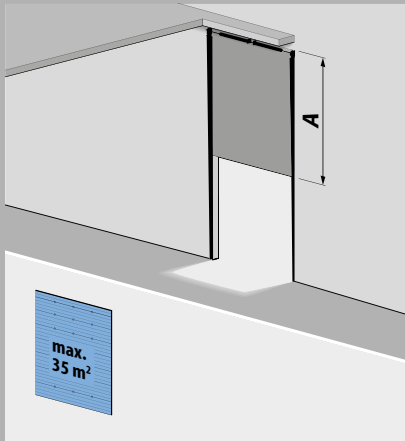

**T 500 (B550),
vertical rail system**

A= open height + 560 mm,
B= n/a

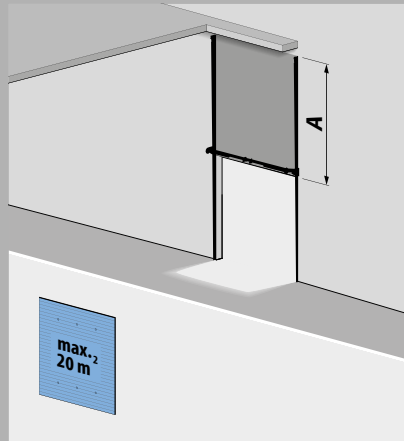

**T 500 hF (B550),
vertical rail system
with low spring axis +
steel support profile**

A= open height + 400 mm,
B= n/a
Width max. 4,500 mm

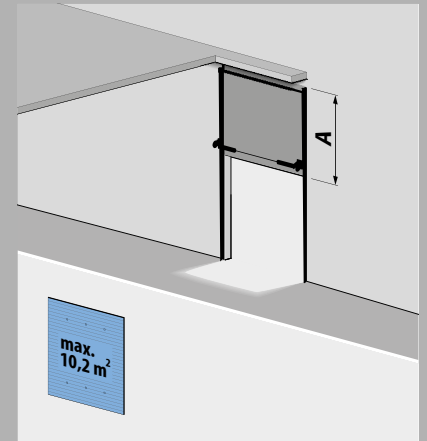

**T 500 DS (B550 dock),
vertical rail system
with low spring axis**

A= open height + 400 mm,
Width max. 3,200 mm
Height max. 3,200 mm

Operators

Novoferm offers a variety of operators for powering overhead doors. A manual system is ideal for doors that are not used frequently, while an electrically powered system with touch control is best for doors that are in constant use. Depending on the door configuration and your requirements, there is always a mechanism to suit your needs. All our drive systems and operators meet the European EN-13241 standard.

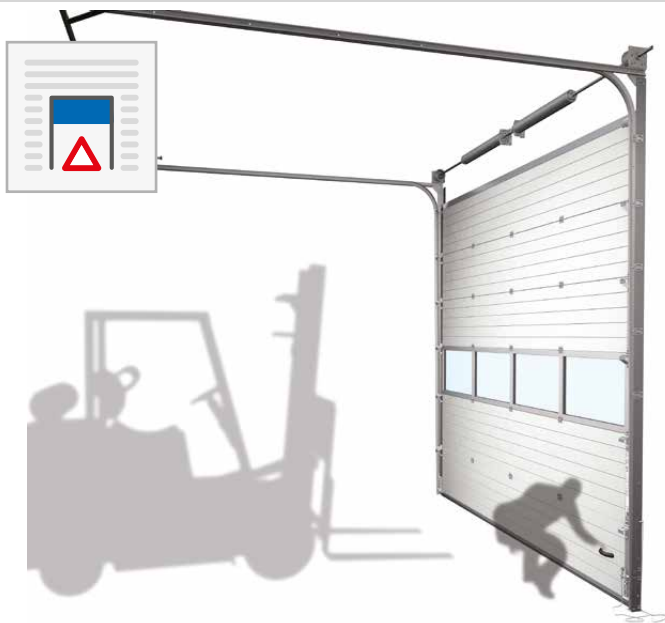

Pull cord – manually operated

If your door is smaller than **16 m²** and you only use it every once in a while, your best option is the pull-cord mechanism. However, the system requires physical exertion (1:1 ratio) and there is a risk the door will not be opened high enough, which may result in damage.

Chain hoist – manually operated

The chain hoist requires less physical exertion than a pull-cord (1:4 ratio). The system – suitable for overhead doors up to **30 m²** – ensures that the door can be secured in the uppermost position.



Dead man's switch – electric

This system is an excellent choice when a door is used infrequently. One push of the button is all that's needed to open the door, although you have to keep it depressed to close the door. This enables the person operating the controls to keep an eye out for any dangerous situations that may arise while the door is closing.

Touch control – electric

If the doors are in constant use, use a touch control. The door raises or lowers automatically to a set position, which can be electronically adjusted, without having to keep the button depressed. An obstacle detection system is built into the door's bottom seal.

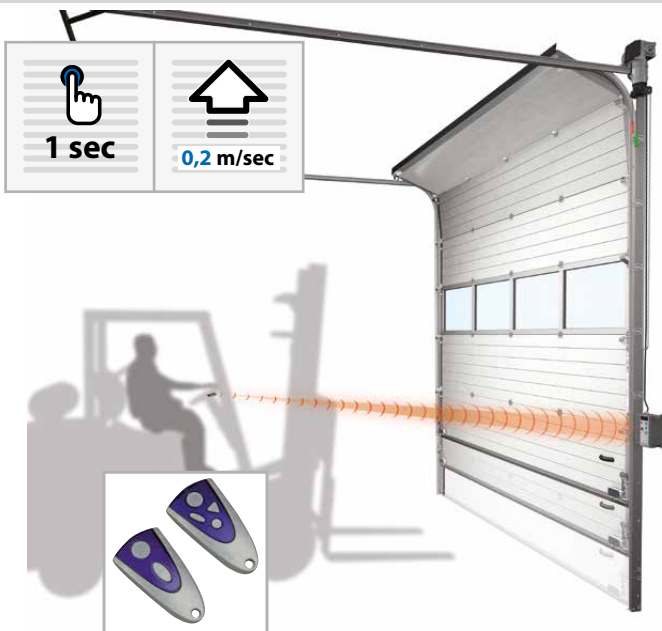

One touch with remote control

The touch control system is also perfect for remote operation and can save a lot of time, because it allows the forklift driver to remain seated while the door is opened or closed remotely. This option includes a stationary photoelectric safety sensor, which is fitted to the door.

Touch control with remote control and high speed motor

If the doors are in constant use then go for a touch control. The door raises or lowers automatically to a set position, which can be electronically adjusted, without having to keep the button depressed. An obstacle detection system has been built into the door's bottom seal.

Control box features

Novoferm offers a wide range of top-quality controls for your overhead door, that can be integrated into the door system's control box. Numerous elements can also be mounted on an interior or exterior wall, a pillar or anywhere else, including safety devices, switches, remote controls, warning lights and much more.



Main switch with padlock

The main switch can be used to turn off the power so that the door system can be serviced. Securing this switch with a padlock prevents unauthorised people from accidentally turning the power on while the service is being carried out.



Key switch

The key switch is used to disable the control box and prevent unauthorised people from operating the door. Only authorised people have a key to activate the door.



Emergency stop

Novoferm offers the option to have an emergency stop installed in the control box when local, national or international legislation stipulates that an electrically operated overhead door must have this safety feature.



Wireless communication

The control box and the connection box on the door panel are usually connected by means of a spiral cord. Unfortunately, this cord can get in the way and get damaged.

That is why Novoferm supplies wireless connection boxes that can transmit signals, such as safety edge detector signals, wirelessly to the control box.



Motor VL

The Motor VL is a special edition of the overhead door that has an electric drive without counter-balance springs.

Due to the high opening speed and the heavy duty quality of the door, it is suitable for fast and frequent opening. Combining it with a rapid roller door to keep the indoor temperature at a constant level is not required. A considerable saving in costs!



Motor with emergency chain

All the drive systems have a mechanical back-up system fitted to the reduction gearbox of the electric motor, so that the overhead door can be opened if the power fails. It must be activated and deactivated manually using pull cords.

The reduction gearbox can then be powered using the chain.



Motor with release system

The motor can also be fitted with a release system. Cables are used to disconnect the reduction gearbox from the spring shaft, which means that the overhead door can be opened faster in the event of malfunctions. It goes without saying that overhead doors with a release system are fitted with a spring break safety device.

Extra control features

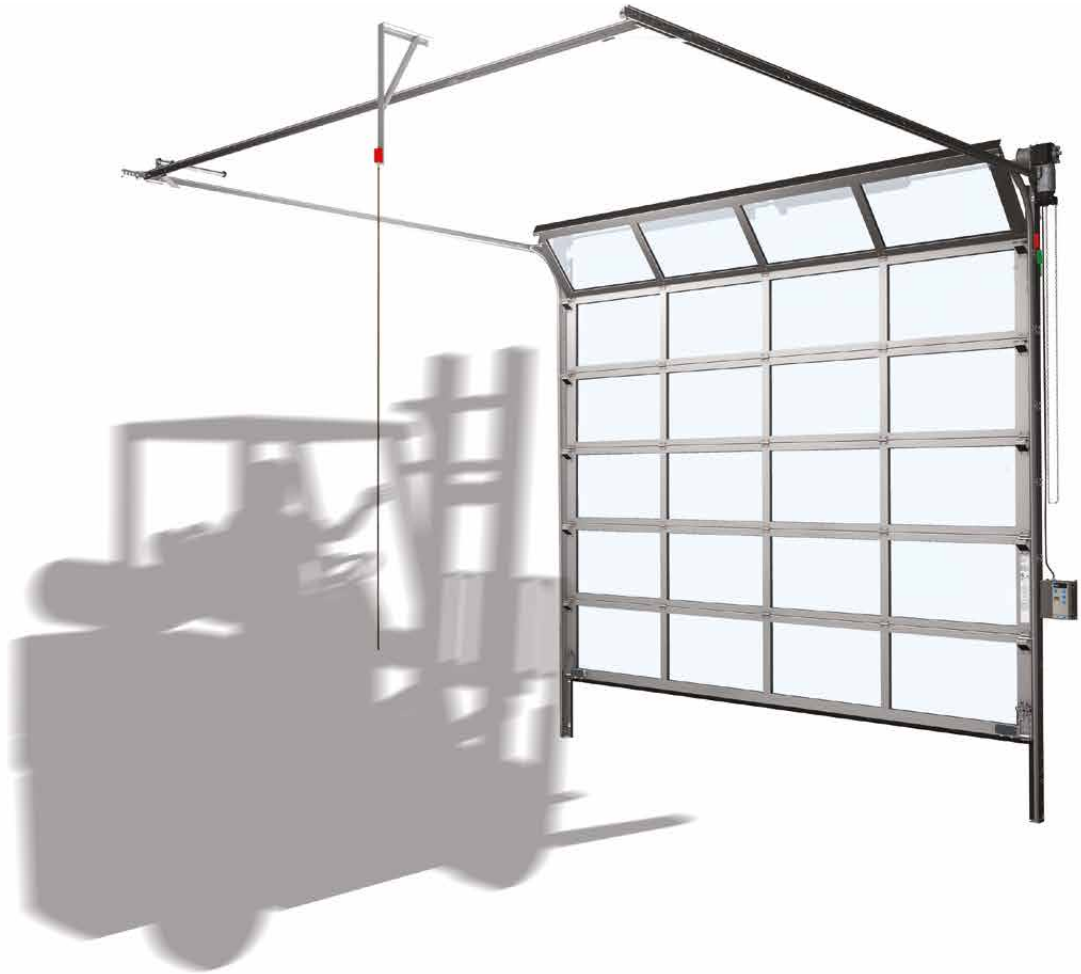

Key switch

The door can be operated using a separate key switch, which can be mounted on the exterior wall. There are two models: the built-in version, which is used a lot in new properties, and the mounted version, which can be installed during a renovation without having to break or dismantle anything.

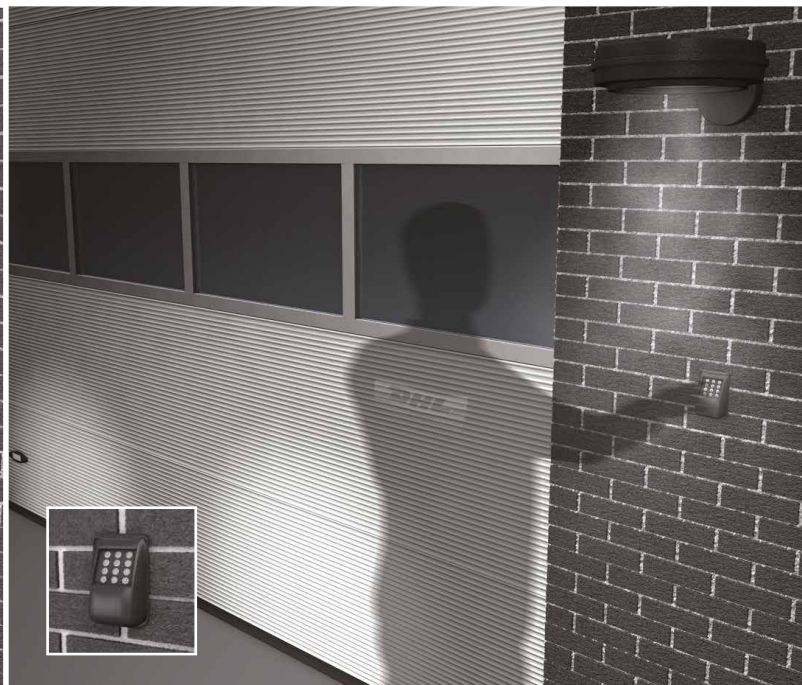

Electronic keypad

If access to a door is required 24/7, it can be fitted with an electronic keypad. This is particularly handy if transport and courier companies need to have round-the-clock access to secure collection or delivery points.



Extra control panel

An extra control panel is the ideal solution if a door needs to be operated from multiple places or remotely, such as from a guardhouse. This handy 'up-stop-down' box features all the buttons of the standard control box.

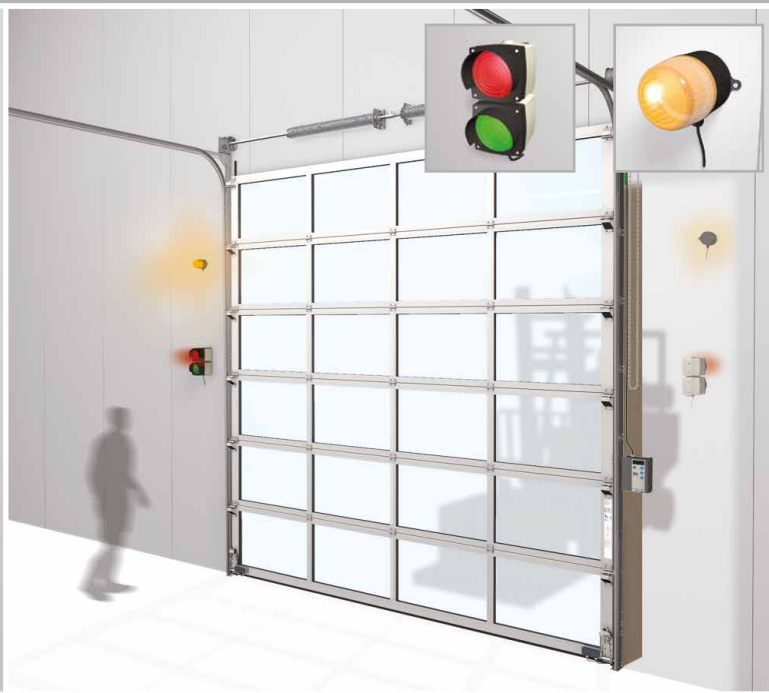

Traffic lights and warning lights

Traffic lights and warning lights installed on either side of a door are an effective way of preventing injury to people and damage to the overhead doors and goods. Warning lights alert people and light up before a door opens, while traffic lights control the traffic and prevent damage to the doors.

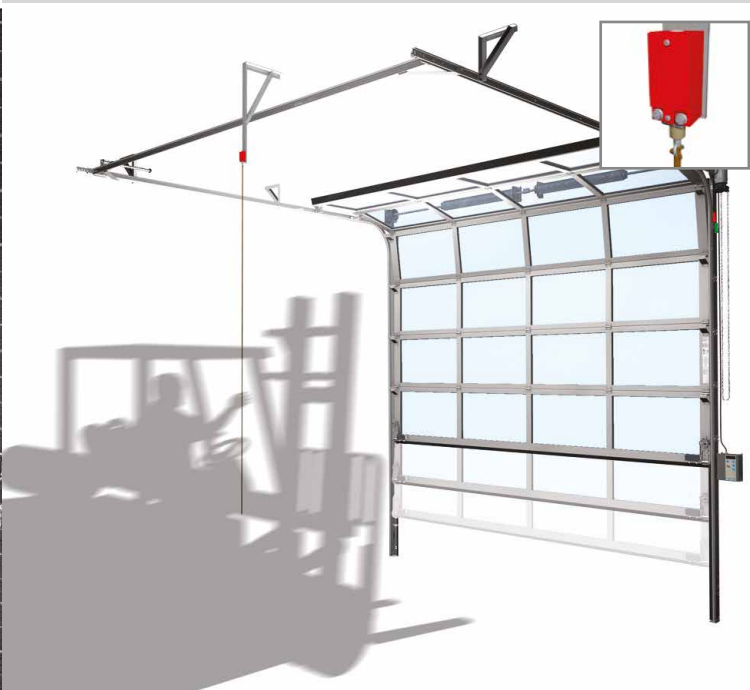

Pull switch

The forklift driver can use the pull switch to operate the door while staying seated. This is the ideal solution if you have a lot of employees, but don't want to give all of them a hand transmitter for the door. The pull switch is often mounted on a frame a few metres in front of or behind the door.

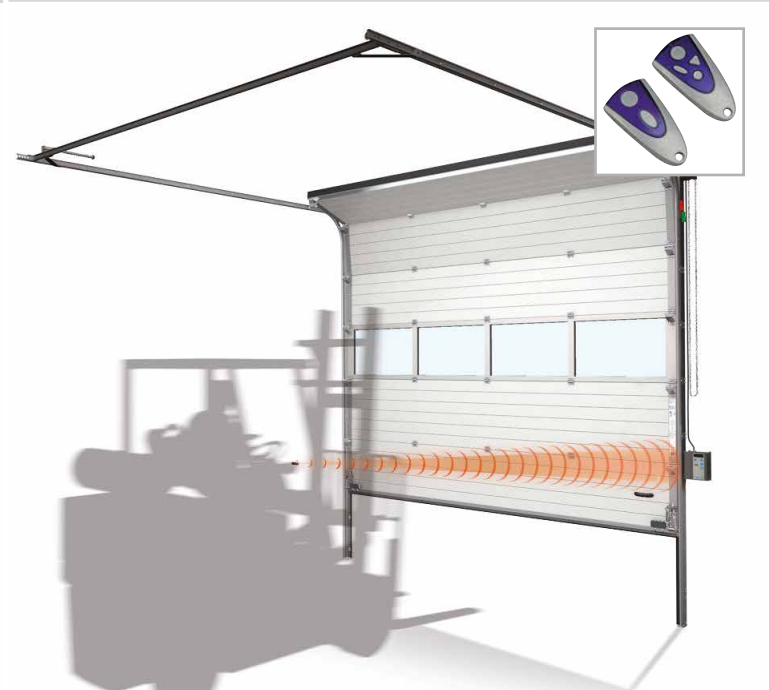

Remote control

Novoferm has included a receiver in your door's control box, making it easy to upgrade the door system to a remote-controlled one. You can choose between one, two or four-channel transmitters, which can operate four different doors.

Mechanical safety devices

Safety is important when it comes to the often heavy vertical overhead doors, so Novoferm offers mechanical and electric safety devices that prevent the door from coming into contact with people, vehicles and obstacles, and causing injury or damage to the doors and/or goods. Excessively safeguarding an overhead door is often unnecessary and could be disadvantageous, as it requires things like extra space for installation and use and could result in components obstructing or even damaging each other. That's why Novoferm recommends you always observe the safety rules. We provide optimum safety systems that are certified by TÜV Nord and meet the very strictest requirements and standards.





Spring break safety device

The European EN-13241-1 standard stipulates that an overhead door may never descend without being controlled. All manually operated overhead doors must therefore be fitted with a spring break safety device. This device blocks the spring shaft in the event of a spring breaking and prevents the door from crashing down. With motor driven overhead doors, instead of a spring break safety device there is a self-locking gearbox. This means a spring break safety device is unnecessary, as it is only required for a motor with a release system.

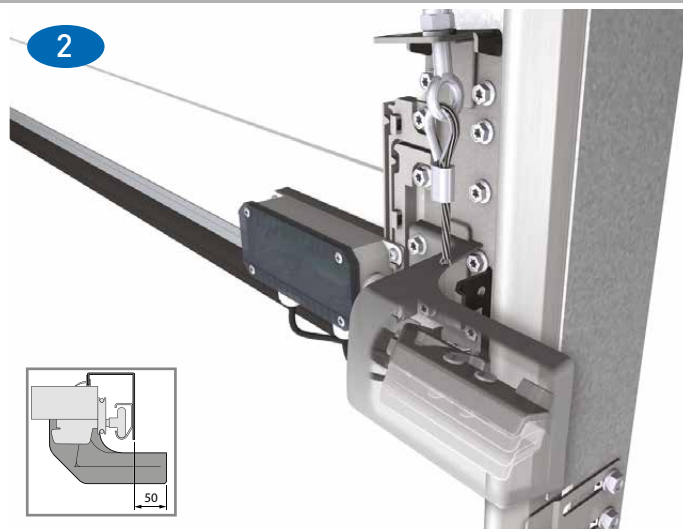

Cable break safety device

The TÜV sets out that the breaking load of both hoisting cables must be six times the weight of a balanced door panel. A cable break safety device is not required if the hoisting cables comply with this breaking load requirement. If that safety margin cannot be guaranteed, then the door must be fitted with a cable break safety device. This device guides safety cables through a system to prevent the door from crashing down should the cable break. An extra 50 mm is required alongside the rail to install a cable break safety device.

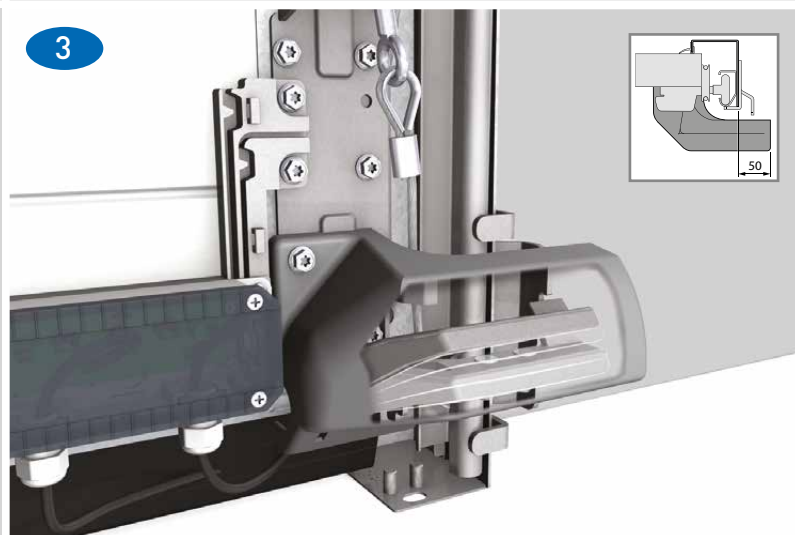
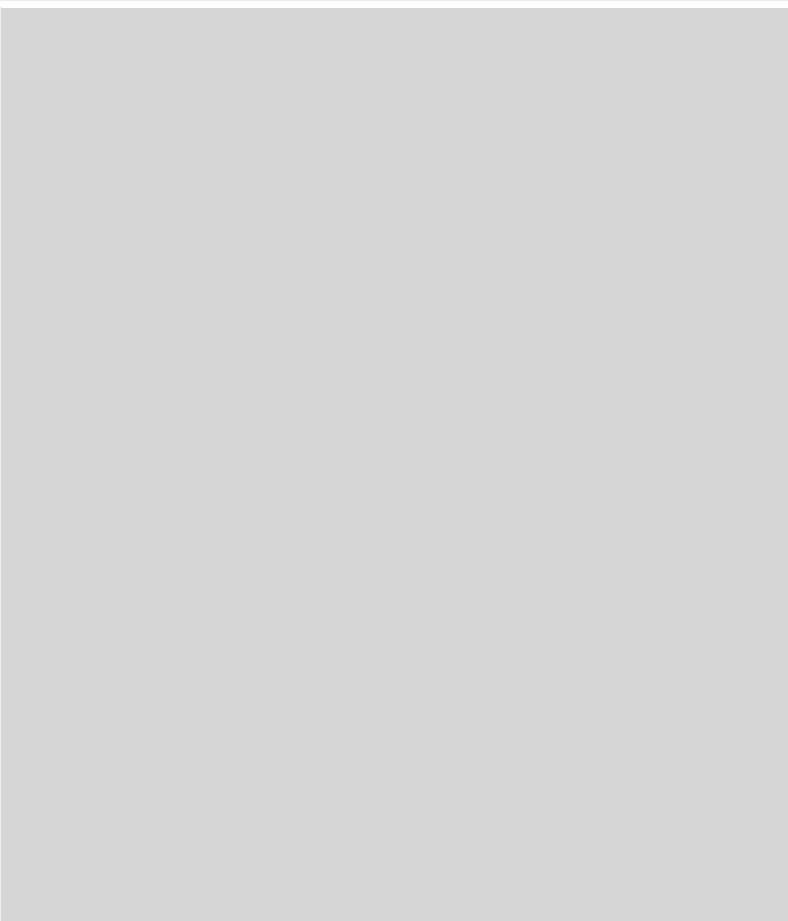

Locking device

Overhead doors are suspended on flexible cables, making it possible to raise them when they are unlocked. Designed especially for light, electrically operated doors, the locking device prevents this, because without it overhead doors are more vulnerable to break-ins. Manually operated doors are fitted with a spring-loaded mechanical slide lock as a standard. An extra 50 mm is required alongside the rail to install the locking device.

Electronic safety devices

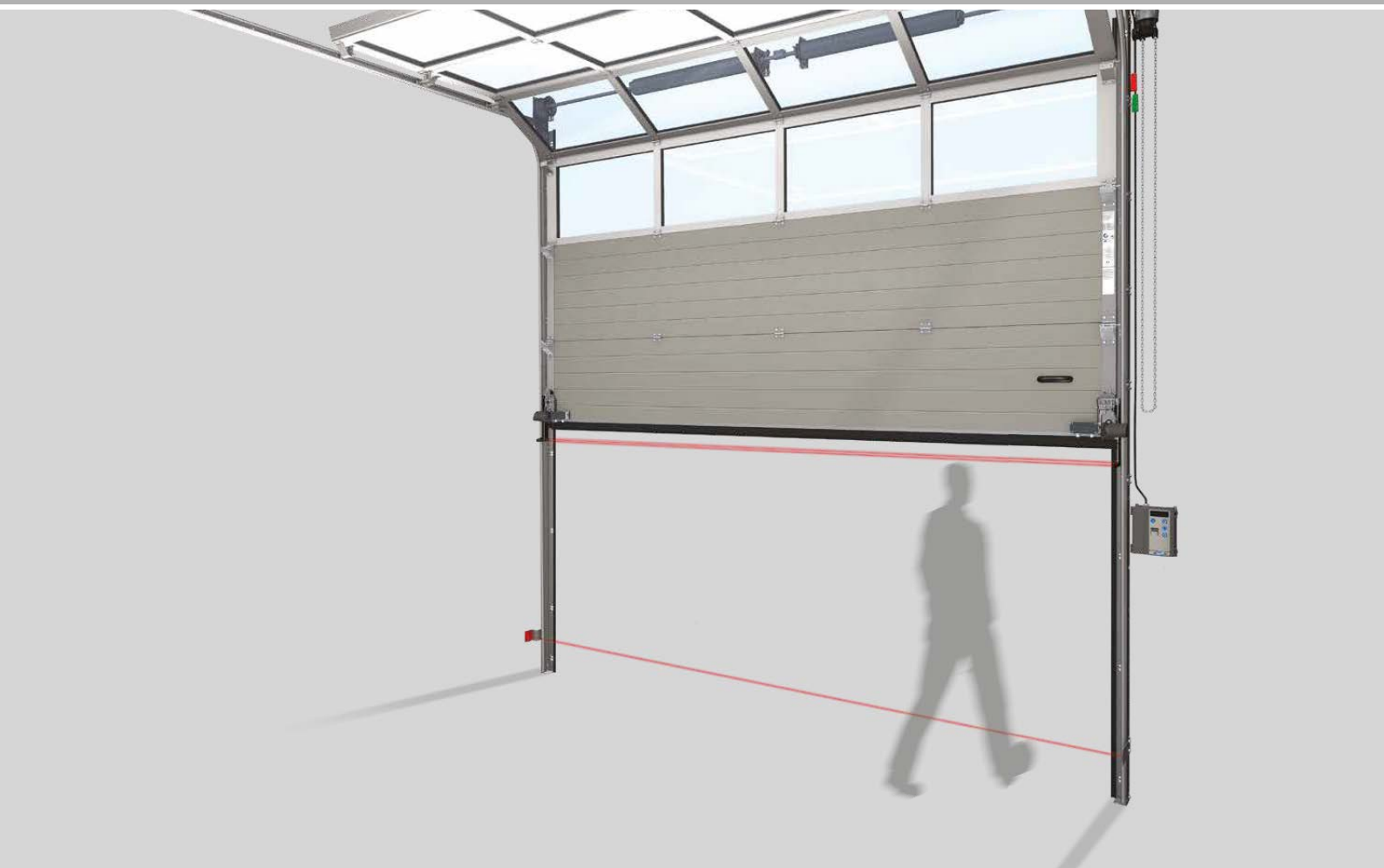

Slack cable device

This safety device is installed on both hoisting cables and immediately disconnects the motor if one of the cables breaks or becomes slack.



Standard safety edge

The safety edge device is integrated together with a transmitter and receiver in the door's bottom rubber seal. If the signal is broken by an object or person, the door will stop and retract. The maximum contact pressure for the rubber seal is 40 kg. Choose the predictive obstacle safety edge if you have products that cannot withstand that level of pressure.



Predictive safety edge

The predictive safety edge is located 8 cm ahead of the door. If the bottom of the door approaches an obstacle, a signal is immediately sent to the motor and the door stops and reopens. This means the safety edge works without coming into contact with people, goods or transport vehicles.

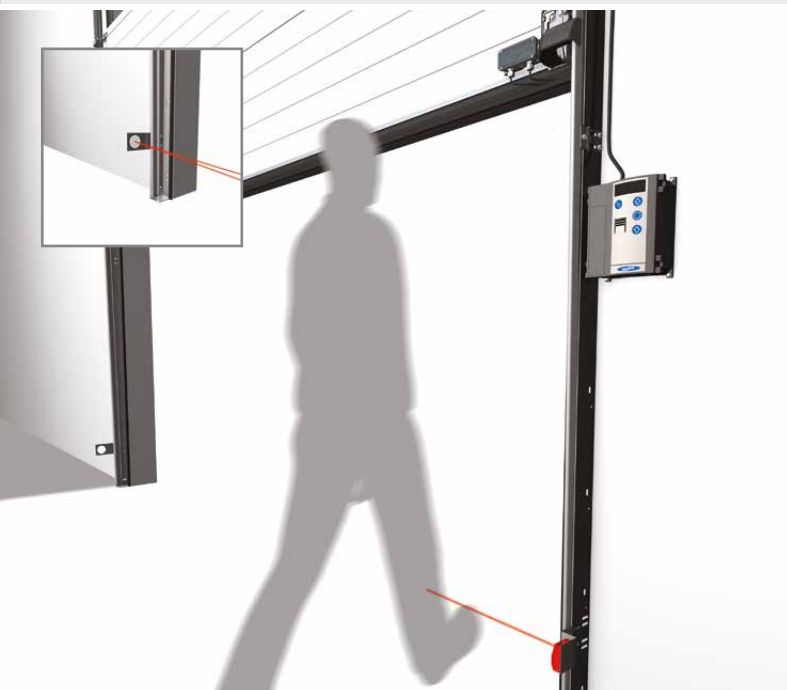

Stationary photoelectric safety sensor

Motors with touch control must have a photoelectric safety sensor if the door opening is not visible to users while they are operating the door. There are two types: a model with a transmitter and reflector and a model with a transmitter and receiver. In both systems there is a transmitter attached to the rail on the control box side and a reflector or receiver



attached to the opposite rail. If the beam between the transmitter and the reflector/receiver is broken, a signal is sent to the motor to stop and reverse the movement. While the reflector system is sensitive to dust and moisture, this is not the case for the receiver model.

Wicket- and Side-doors 40/60 mm



For keeping people and goods apart

While a wicket door can be built into an NovoLux or Thermo Novoferm door, we recommend that wherever possible pedestrian traffic and goods traffic be kept apart. In other words, a permanent wicket door in the façade, separate from the overhead door, or a permanent wicket door next to the overhead door. The wicket door can be built into the overhead door, but this may affect the door's stability. It also presents limitations in terms of the door's width, height and threshold height, as a result of which the gate may not meet the current legal requirements for an emergency exit. Always discuss your plans with the local authorities so you can be sure you're choosing the right wicket door.

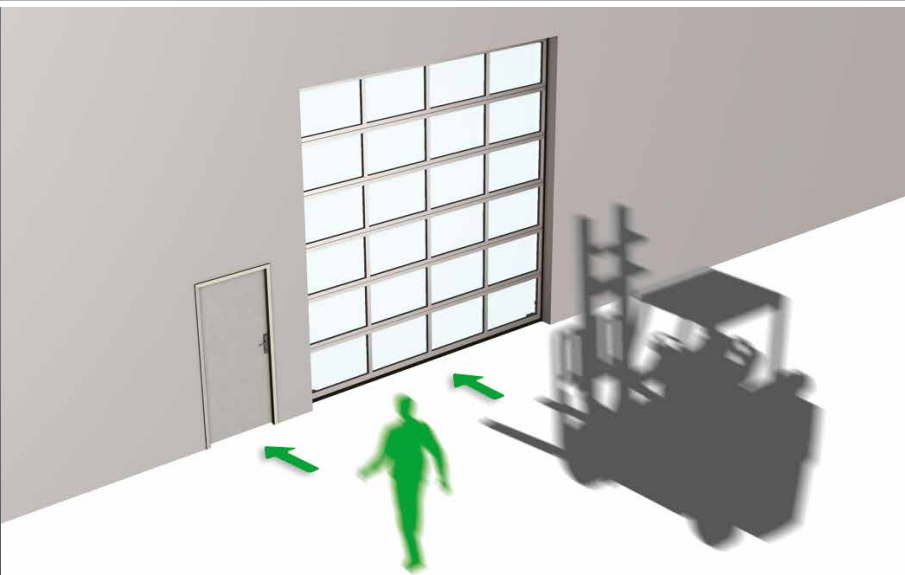

Completely separate doors for pedestrians and goods.

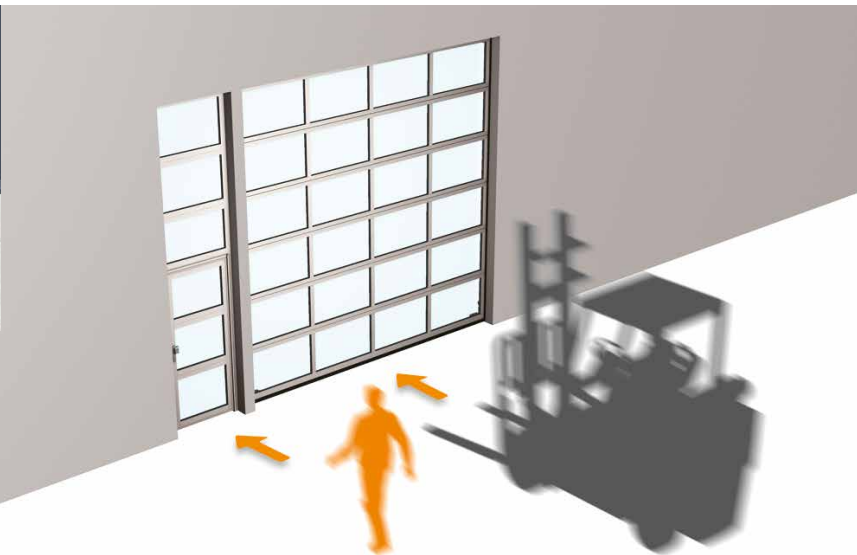

Separate doors for pedestrians and goods, but in the same opening structure.



Wicket door for people built into an overhead door for goods.



Permanent wicket door next to the overhead door

The advantage of a permanent wicket door is that the doors for pedestrians and goods are completely separate.

This increases safety, ease-of-use and the stability of the overhead door.

A permanent wicket door is installed in the façade next to the overhead door, where the design and panel structure of the wicket door and top panel match the structure of the overhead door, unifying them and making them both architecturally and aesthetically pleasing.



Choose the right door

A permanent wicket door can open both inwards and outwards and you can choose between a left-hinged DIN standard door or a right-hinged DIN standard door. If the wicket door is also to be used as an emergency exit, the door must open outwards.

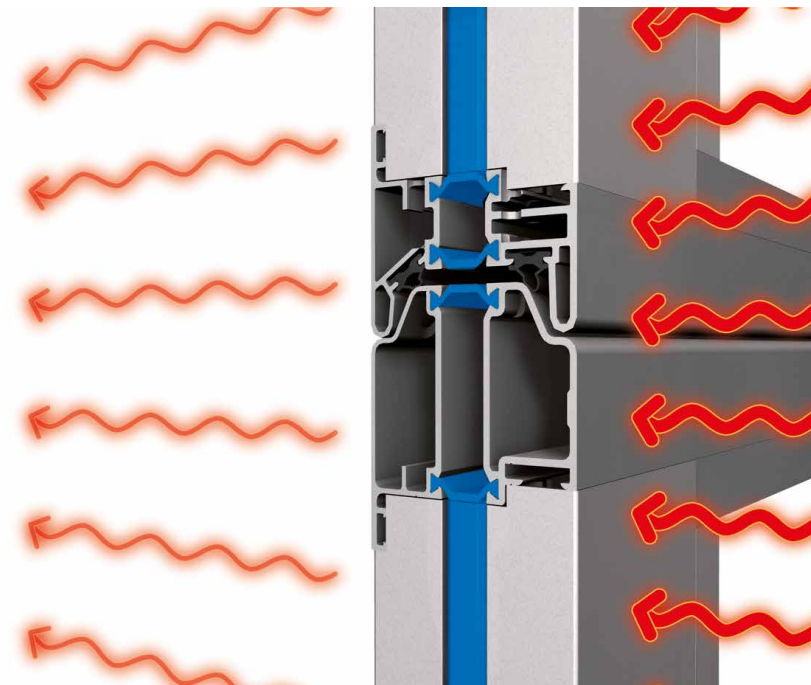
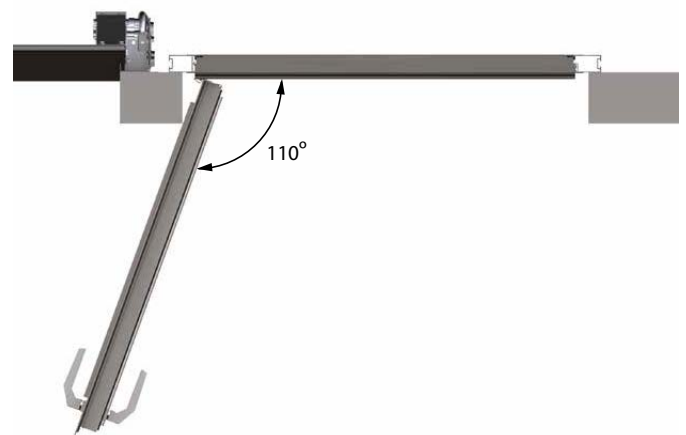
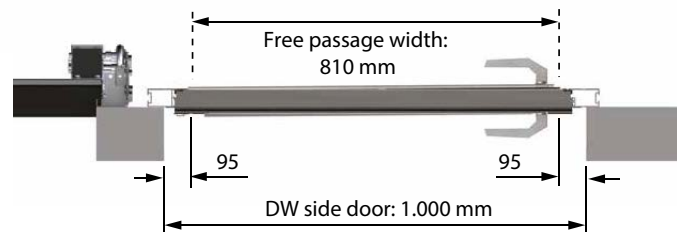

Section seals

The sections of the NovoLux 60 door are specially sealed to make them completely wind and waterproof. Any heat transmission is prevented by the special insulation profiles.

Installation onto or in the opening

An overhead door is always built against the interior side of the opening, so if you wish to install a permanent door in the same façade, Novoferm will likewise always install it behind the opening. This has two advantages: firstly the doors are aligned, and secondly the width of the wicket door is 810 mm ($1,000 + 50 - 240 = 810$ mm) for a 1,000 mm opening. The first aspect is aesthetically pleasing, while the second means a gain of 60 mm compared to when it is installed in the actual opening.

If the wicket doorway is installed in the opening itself, the wicket door will stand forward from the overhead door and its width will only be 750 mm ($1,000 - 10 - 240 = 750$ mm) in the same 1,000 mm opening.

Wicket door built into the overhead door

If you cannot install a permanent wicket door in the façade of your building, Novoferm can build a wicket door into the overhead door. We offer various options for this, all of which meet the very highest structural, aesthetic and safety requirements. The built-in wicket door has a sophisticated integrated hinge system, an accurately-aligned locking system with stabilising pins and an integrated safety switch. Three choices are available for the threshold height: 16, 110 and 195 mm.





1

Integrated wicket door switch

The wicket door switch, which is fitted under the safety catch, is an integrated safety device that prevents the overhead door from being operated when the wicket door is open.



2

Stabilising pins

The wicket door is held in perfect position by the stabilising pins. This means that the door will never "droop".

The pins also create a more effective seal between the wicket door and the door. The magnetic contact of the wicket door switch is fitted beneath the pin.



3

Divider

A wicket door can never be positioned in the outermost parts of an overhead door, as this would affect its stability. The picture shows where the door can and cannot be installed. Wicket doors can be installed in overhead doors with a maximum door panel width of 6,000 mm. If you have a wider door, you will have to consider alternative options.



4

Aesthetically appealing wicket door

Novoferm recently made significant improvements to its wicket door design, the main one being the integration of the hinge system into the overhead door. This means the fastenings are no longer visible on the exterior and the standard NovoLux wicket door profiles do not protrude as much.

Optional extra: coloured wicket door profiles

If you choose a coloured Thermo or NovoLux overhead door with a built-in wicket door, the wicket door profiles do not have to have the same colour as the door. This option is up to you, and while some people prefer a clearly visible wicket door, others like theirs to be less conspicuous. Novoferm offers you both options.



5

16 mm threshold

To restrict the risk of tripping when evacuating the building, Novoferm has created a low 16 mm threshold. Such a low threshold meets on certain conditions national directives on emergency exits.

Integrated wicket door as an emergency exit

If you intend to use the built-in wicket door as an emergency exit, talk to the local authorities first and enquire about the regulations. The authorities stipulate the conditions that the wicket door must meet, depending on the number of people working or otherwise present in the building. As a rule, four aspects determine whether a wicket door is suitable as an emergency exit: the type of lock, the door width, the door height and the threshold height. Lastly, an integrated wicket door must always open outwards, as is required for any door that serves as an emergency exit.



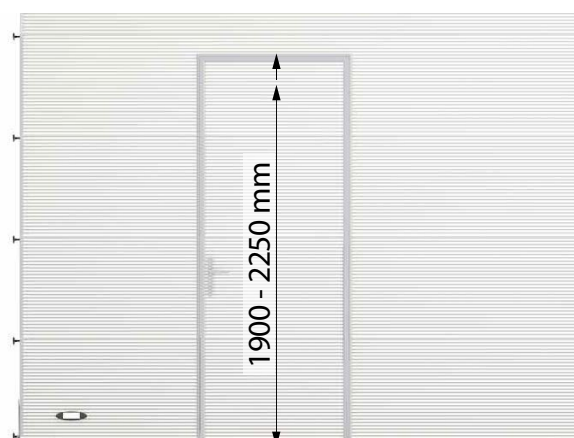

Door width and height

The legislative and inspection bodies stipulate that a wicket door which is to serve as an emergency exit must be of a minimum width and height, according to local or national regulations. The maximum width of an integrated wicket door is 940 mm and the maximum height is 2,250 mm. Talk to your local authorities if your wicket door is to serve as an emergency exit.



Panic lock

A wicket door that is to function as an emergency exit must be fitted with a panic lock. Various types of panic locks are available. A wicket door with a panic lock can always be opened using the latch on the inside, even when the deadbolt is secured.

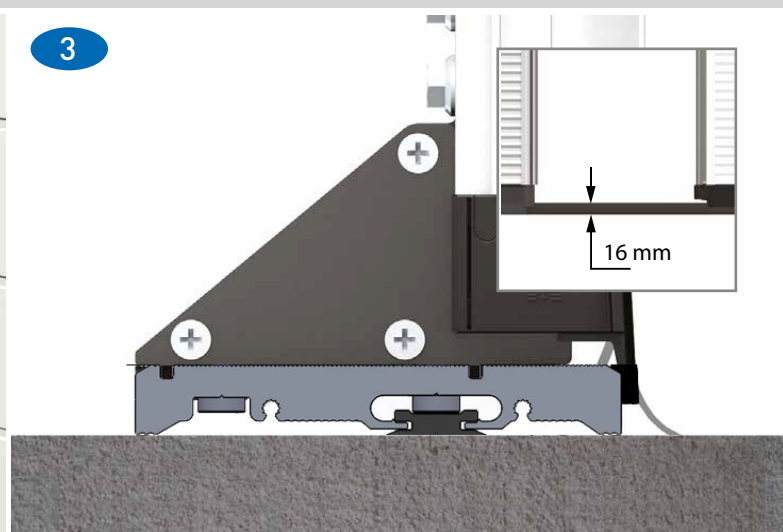

16 mm threshold

To restrict the risk of tripping when evacuating the building, Novoferm has created a low 16 mm threshold. Such a low threshold meets on certain conditions national directives on emergency exits.

Wicket door accessories and options

Novoferm invests heavily in creating options for the optimum integration of wicket doors into overhead doors. One of the main areas of attention is safety and ease-of-use, with special consideration given to making hinges, switches, security locks and locks as aesthetically pleasing as possible. We would also be happy to provide you with detailed individual advice on the available options for threshold heights, the direction in which the door opens, its dimensions and its position.

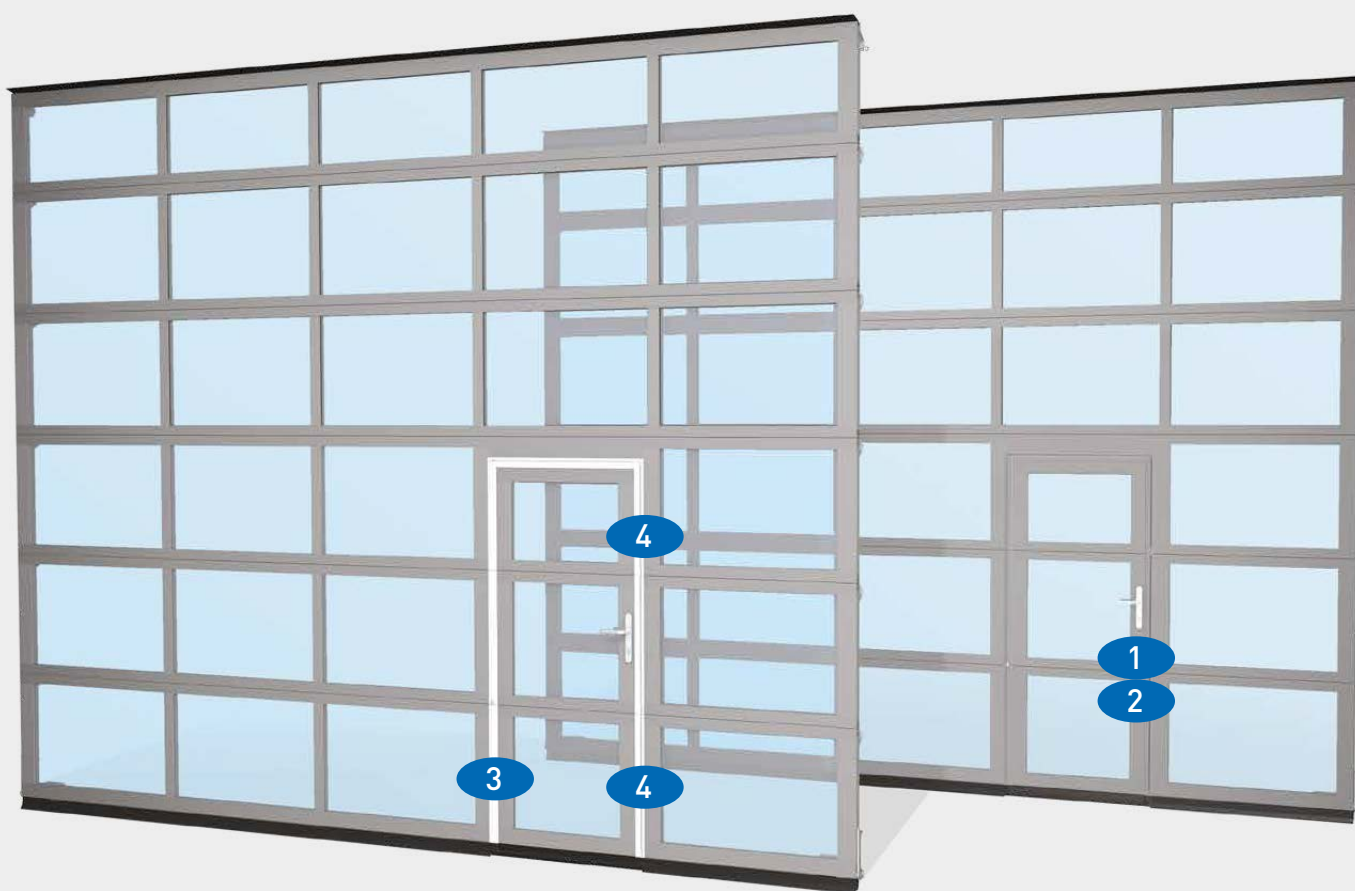

The Novoferm wicket door lock range comprises six locks: two standard locks and four panic locks (if the wicket door also functions as an emergency exit).

Standard locks

- Lock with a handle on either side
- Lock with a fixed panel on the outside and a handle on the inside

Panic locks

- Panic lock with a fixed door panel on the outside and a handle on the inside (panic function E)
- Panic lock with a handle on either side (split tumbler, panic function B)
- Panic lock with a fixed panel on the outside and push bar on the inside (panic function E)
- Panic lock with a handle on the outside (split tumbler) and push bar on the inside (panic function B)

Depending on the situation, the fire brigade may stipulate that panic locks be installed.



Panic lock, with panic function E

With the type E panic lock, the door can always be locked with a key from inside. When the interior handle is turned, the latch and deadbolt are simultaneously retracted into the lock. The panic release function can only be used when there is no key in the cylinder. The latch and deadbolt can only be opened from outside with a key. The deadbolt stays in the lock after the panic function has been used.

Use this lock if the wicket door is to serve as an emergency exit, but not as an entrance during the day.



Panic lock, with panic function B

The type B panic lock is operated from inside in the same way as the type E panic lock, but there is a handle on the outside that can be locked and unlocked. This means that, if required, the door can serve as an entrance during the day.

The lock works as follows: the wicket door can always be locked and unlocked from the outside with a key; when the deadbolt is locked using the key, the exterior handle will disengage and nothing will happen when it is turned.

The exterior handle will remain disengaged even when the panic function has been used and the deadbolt has been retracted into the lock. The night bolt stays in the lock after the panic function has been used. The lock can only be used with the exterior handle when the key is inserted into the cylinder, which re-engages the exterior handle.



Coloured wicket door profiles

If you choose a coloured Thermo or NovoLux overhead door with a built-in wicket door, the wicket door profiles do not have to the same colour as the door. This is a matter of personal preference, and while some people prefer a clearly visible wicket door, others like theirs to be less conspicuous. Novoferm offers you both options.



Additional security locks

For added safety, you can have two extra security locks fitted to the top and bottom sections of the wicket door. The same key can be used for all cylinder locks. The additional security locks have handles, so they can be opened without a key.



The superfast and space-saving Spiral-door

Novoform sets itself ambitious targets in the areas of insulation, noise and pricing. Our research & development department has succeeded in developing an unprecedentedly fast overhead door that also offers exceptional insulation performance: the NovoSpeed Thermo. Specially designed rollers keep noise to a minimum. This patented system also contributes to the sleek design of the NovoSpeed Thermo.

Traditionally, two doors are often mounted in frequently used exterior openings; an insulated door for use at night and a high speed door that is used during the day. The new NovoSpeed Thermo combines the best of both worlds in a single product.

An investment that pays for itself in next to no time!

The S600 has the identical drive system as the NovoSpeed Thermo door but has a standard track system. This door opens 6x faster as a similar overhead door but can be installed into a headroom of only 600 mm. The NovoSpeed Thermo and S600 have a standard section height of 366 mm.

If you have insufficient back room for the S600 you have the solution of the NovoSpeed Thermo with a faster speed!



The best of all Worlds, the NovoSpeed Thermo / S600

Speed

The NovoSpeed Thermo-Door opens 6 x faster than similar overhead doors and is therefore extremely suitable in an environment where you have intensive logistic movements.

This door opens fast and depending on the door size up to 1.1 M per second and real savings on the energy cost can be achieved.

Energy-saving

The door leaf has a thickness of 40mm and a U-value of 1.77 W/m²K (Thermo panels / door leaf 5000 mm x 5000 mm). Additionally where requested we can provide high quality full width NovoLux vision sections.

Space-saving

The NovoSpeed Thermo Door is a revolutionary innovation and thanks to the spiral system and chain drive does not require extended backroom. To minimize wear and tear the Spiral action of the door means the panels do not touch, roll or fold upon themselves. The NovoSpeed Thermo offers a solution in a room where the ceiling construction does not allow track hangers for a regular overhead door.

Durability

Because of the intelligent drive-system without counterbalance, the NovoSpeed Thermo door does hardly need any service upto 200,000 cycles.

Scopes

- Logistics
- Automotive industry
- Machine building
- Metal- and electrical-industry
- Food-industry
- Chemical and pharmaceutical industry



U-value NovoSpeed Thermo / S600 Thermo 40 mm
overhead door: 5,000 x 5,000 mm: 1.77 W/m²K

U-value NovoSpeed Thermo / S600 NovoLux 40 mm
overhead door: 5,000 x 5,000 mm: 4.25 W/m²K

Technical details



2 Colours

Do you have special requirements when it comes to the colour? Novoferm can offer you a whole rainbow of colours.

Specifications	NovoSpeed Thermo	S600
Max. Door leaf-surface	25 m ² (350 kg)	25 m ² (350 kg)
Max. Width	5000 mm	5000 mm
Max. height	5000 mm	5000 mm
Opening speed	1.1 m/s	1.1 m/s
Closing speed	0.5 m/s	0.5 m/s
Section-thickness	40 mm	40 mm
Section-Joint	Finger-protection	Finger-protection
NovoLux-sections option	yes	yes
U Value at 5.000 x 5.000 mm	1.77 W/m ² K (complete Thermo)	1.77 W/m ² K (complete Thermo)

FEATURES AND BENEFITS

- Low maintenance. (200,000 cycles) Springless system.
- Pre-running safety-edge or light-grid (no wiring on the door leaf).
- Class 3 Wind load.
- High insulation value.
- Quick and simple installation because of pre-assembled track-and drive-system.
- High opening speed.



2

Section Joint

The joint between the Thermo and NovoLux sections is wind and watertight to (class 3 wind load)



3

Torque-tube

The NovoSpeed Thermo and the S600 are equipped with a direct drive aluminium Torque-tube and is without spring assistance.



4

Compact Side-hinges

For extra safety the panel connecting hinges are almost flat and ensure a perfect seal with the vertical side seals.



5

Drive-concept

The uninterrupted chain-/steel-cable system ensures precise and controlled door-movement even at high speed.



6

Safety

The NovoSpeed Thermo as the S600 can be equipped with pre-running safety-edge or a light-grid. The light-grid is consisting of a receiver and transmitter, mounted into the track system, and therefore no wiring is required on the door leaf. This improves the operational reliability of this superfast door.

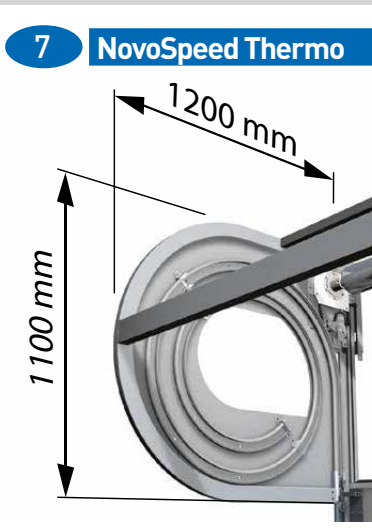

7

NovoSpeed Thermo

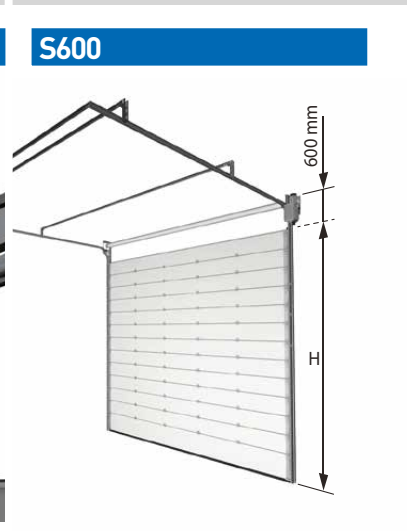
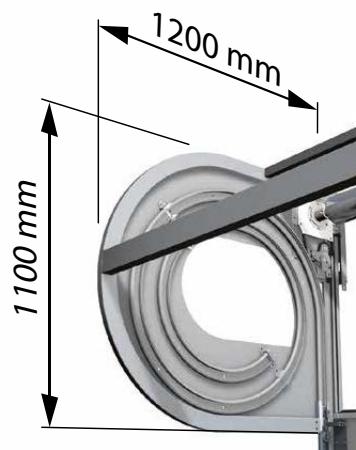

S600

Installation space

The NovoSpeed Thermo Door coils itself up against the interior facade of the building and the build in space is 1100 mm x 1200 mm at the head, 350 mm on the drive side and 120 mm on the non drive side.

References





Other Novoferm products



Novo Docking Solutions

Novoferm Docking Solutions are tried and tested, technically perfected, from a single source ensuring that your material movement results in added value. All our docking solutions are tailored to your individual requirements in the design process.



Novo Speed Solutions

High-speed doors open and close extremely fast and, in addition to optimised processes, ensure constant temperatures in production halls and workshops. These door systems enable you to use existing potentials and reduce your overheads! High-speed doors are available in many different designs and custom sizes.



Fire protection sliding doors

Novoferm fire protection sliding doors close automatically and prevent fire penetration through openings in the walls. They persuade through their operating characteristics and attractive look. Thanks to the shipping and installation friendly modular construction, large-size doors can also be realised.





Rolltore und Rollgitter aus Alu oder Stahl
Synthese aus Funktionalität und Flexibilität



Rolling doors and roller grilles

Our rolling doors are individual and universal door systems. They comply with all valid guidelines and standards and installation is also performed according to existing DIN regulations. Thanks to the profile design and superior transparent coating of aluminium doors, your rolling door is good promotion for your company.



Für jedes Bauobjekt die richtige Tür
Anwendungslösungen für Gewerbe und Industrie



Steel doors

We offer a wide range of modern fire protection and multi-purpose doors. Our strength lies in the provision of complete bespoke solutions, which are tried and tested while being innovative at the same time. We make our products in accordance with the latest technical developments, and in this respect, we do not only meet high quality requirements, but we also combine an extensive functionality with an attractive design.



Feuer- und Rauchschutzabschlüsse in Profilrahmenkonstruktion
Türen und Wandelemente für zeitgemäße Glasarchitektur



Fire and smoke protection door systems

The glass frame constructions persuade through their elegant look and numerous design and combination possibilities. Door and wall elements are available in steel and aluminium. Fire protection elements are also available in stainless steel. Thermally insulated elements can be supplied in steel.



The complete package from a single source.

Our production is controlled and in full accordance with strict European laws and norms. We guarantee the highest quality as we only accept components from trusted and preferred suppliers worldwide. In addition and to offer the complete assortment we have forged strategic partnerships with other like-minded producers of Industrial Doors. Uniquely and from a single source Novoferm guarantees the complete package with the highest quality.

Novoferm dealer:

Issue 04-2020 | We reserve the right to implement technical changes and there may be printing errors

United Kingdom

Novoferm Ltd UK

Phone.: +44 (0) 1582 563 777

E-mail: info@novoferm.co.uk

Internet: www.novoferm.co.uk



Intelligent Door Solutions