

**NEW!**

NEW SURFACES AND PATTERNS



## Sectional garage door systems

Welcome home

**novoferm**

# Contents



Why opt for sectional garage doors by Novoferm?



Novoferm quality



Vertical extension spring for sectional garage doors



NovoPort®- operator system



Patterns, surfaces, colours and structures



Pass doors and side doors



DuoPort



Garage door finder

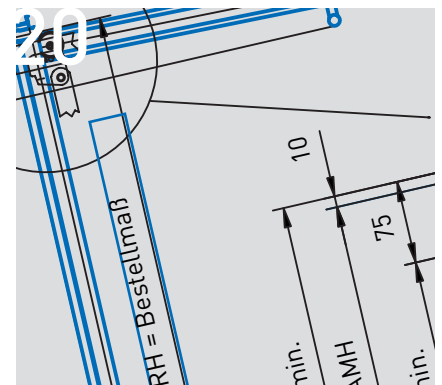

Technology



All Novoferm garage doors and operators are manufactured according to the strict quality management system DIN ISO 9001.

- All Novoferm sectional garage door systems meet the high safety requirements for the European garage doors product standard EN 13241-1.
- All Novoferm garage doors and operators are tested by recognized institutes both individually and in combination.
- What does "TÜV-tested burglar resistance" mean in terms of your safety? The German industry association for garage doors, doors and frames (Industrieverband Tore Türen Zargen (ttz)) has drawn up a guideline that defines burglar resistance based on the existing standards. Tests are performed, and the results certified, by TÜV NORD CERT GmbH. Which means: certified garage doors made by Novoferm guarantee the highest levels of safety that have been tested by an impartial organization.

- There is an optional installation kit for Novoferm sectional garage doors that provides additional burglar resistance and has been tested in accordance with the Dutch standard NEN 5096 at SKG. The burglar resistance has been certified under the standard's class 2.

The 10-year warranty on all steel sectional garage doors, the 5-year warranty on our film-covered garage doors (Golden oak, Dark oak, Mahogany, Winchester, Black oak und Moor oak) and our structural surfaces (Satin White, Satin Grey, Satin Dark Grey and Satin Brown) as well as the 5-year warranty on the mechanical components of the NovoPort® system ensure that you will have many years of pleasure and satisfaction with your new garage door.



# Why opt for sectional garage doors by Novoferm?



## High-quality appearance and durability of our surface finishes

All sectional garage doors and sectional garage side doors with coated (Super-Color or RAL of your choice), film-covered (Golden oak, Dark oak, Mahogany, Winchester, Black oak und Moor oak) and structural surfaces (Satin White, Satin Grey, Satin Dark Grey and Satin Brown) are top coated at Novoferm. These high-quality surface finishes enhance the ability to withstand external influences while at the same time giving your garage an air of sophistication that you will enjoy for a long time to come.



## Premium quality backed up by our warranty

All Novoferm sectional garage doors bear the Novoferm seal of quality. The garage doors and operators are manufactured in accordance with the ISO 9001 quality management system and comply with the stringent safety requirements of European garage door standard EN 13241-1. In addition we give a ten year warranty on all steel sectional garage doors with our seal of quality. Film-covered garage doors (Golden oak, Dark oak, Mahogany, Winchester, Black oak und Moor oak), our garage doors with structural surfaces (Satin White, Satin Grey, Satin Dark Grey and Satin Brown) and the mechanical, motor and motor control components of our garage door operators are protected by a five-year warranty.

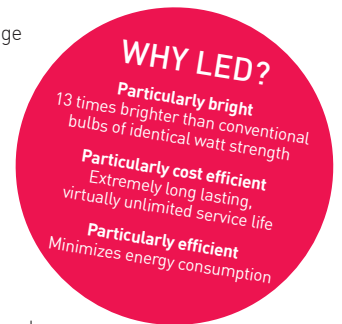

## Insulation and energy efficiency

Our sectional garage doors are fitted with a PUR rigid foam core that is between 20 and 45 mm thick to ensure good to maximum heat insulation. All of our garage door operators and additional hardware (e.g. light strips) are fitted with modern, energy-saving LED lighting for added brightness, cost and energy efficiency. A further benefit in terms of energy savings is that many of our operators only consume 0.5 W in standby. Added to which, the new Thermo frame set guarantees up to 15%\* improved heat insulation.

\* Depending on the door motif and size



## Modernize your garage with an automatic sectional garage door system

Regardless of whether your garage was built from scratch or ready-made: your Novoferm partner can replace the old door with an automatic sectional garage door. Why is the replacement so quick? Since Novoferm renovation garage doors are perfectly matched to most old garage door dimensions, there is no need for elaborate modifications to the garage opening or for costly made-to-measure garage doors. If the new sectional garage door is mounted behind the garage opening, you will also gain more passage width. If space constraints necessitate installation of the sectional garage door in front of the garage opening, we can provide a high-quality aluminium rebate enclosure.



## Tested security

Sectional garage doors made by Novoferm guarantee the highest levels of security! In addition to their functional reliability and the protection they offer friends and family with their anti-pinch protection (inside and out) and torsion spring with spring fracture safety device on both sides (iso 45), their elaborate design is also able to withstand intrusion attempts. Sectional garage doors are protected against possible break-ins with features that include the TÜV-tested burglar resistance\*, electronic push-up protection and a self-locking gear. There is an optional installation kit for Novoferm sectional garage doors that provides additional burglar resistance and has been tested in accordance with the Dutch standard NEN 5096 at SKG. The burglar resistance has been certified under the standard's class 2 They are joined by manipulationproof hand transmitters protected by multi-part rolling codes. \* for all standard design garage doors (excluding additional features, such as pass doors, emergency unlocking mechanisms, windows, etc.)

**NEW:** The new hand transmitters are equipped with AES 128-bit encryption to offer maximum security.

# Quality

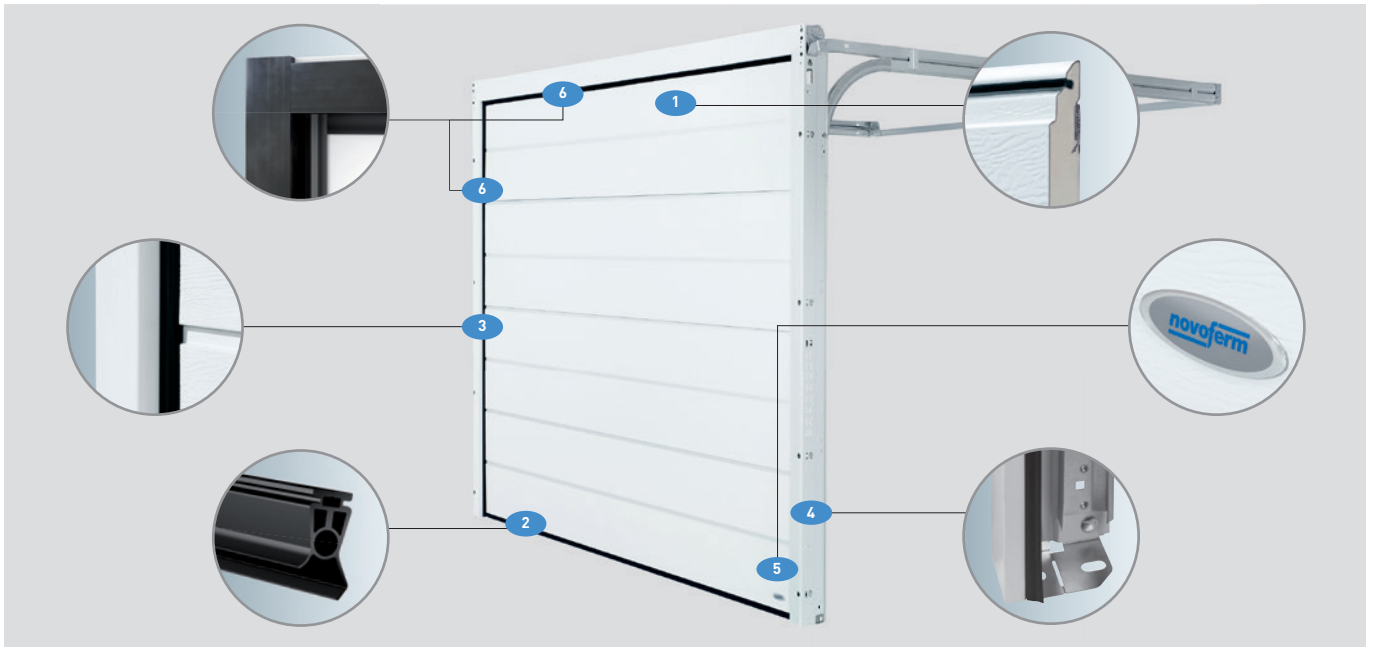

## 1 Double-skinned and insulated

Our steel sections are exclusively manufactured in a double-skinned sandwich construction and filled with an insulating rigid PUR foam core. This ensures improved soundproofing and heat insulation, and quieter door operation compared with single-skinned garage doors. The flexible lip seals between the sections fit softly even at low temperatures. They prevent any heat losses and keep the dust out.

## 2 Frost-proof floor seal

A rubber profile on the bottom edge of the garage door guarantees optimum protection from water and dirt, evens out slight floor unevenness and prevents damage and injuries. The floor seal is made of high-quality EPDM (ethylene propylene diene monomer), which is known for its high elasticity, weather resistance and durability.

## 3 Lip seals on the frame

Extra wide lip seals on the side frame provide even better heat insulation and protection against dirt.

## 4 Adaptable frame base

Novoferm sectional garage doors are fitted with a weatherproof frame base made of hot-dip galvanized steel. So water and accumulated moisture can drain off freely and the frame will not start to rust, even after long periods. The stepped design is ideal for renovation projects that involve the installation of a sectional garage door to replace an up-and-over door with floor track.

## 5 The Novoferm quality seal

Since quality is definitely not something to be hidden, all Novoferm sectional garage doors bear the Novoferm seal of quality, which guarantees the use of the best materials and a top-class finish!

## 6 Thermo frame set

The new optional sealing and insulating strip system further improves the already excellent performance of the double-skinned Novoferm E<sup>®</sup> sectional garage doors. The 3-sided thermal optimization of the frame offers up to 15%\* better heat insulation when mounted behind the opening. A plug and clip profile ensures quick and easy installation; the frame can be used on all Novoferm E<sup>®</sup> sectional doors. The Thermo frame set actively supports the optimization of building performance.

\* Depending on the door motif and size

# Vertical extension spring



Novoferm is now supplying its iso 20 and iso 45 sectional garage doors in widths up to 3,000 mm and heights up to 2,500 mm (smooth) or 2,750 mm (Woodgrain) with a standard vertical extension spring system.

## 1 Interference-protected deflection pulley

The steel cables run vertically into the angular frame on interference-protected deflection pulleys mounted on ball bearings with U-shaped caster holders. This reduces the height requirement compared to the front-mounted torsion spring.

## 2 New cable mount

Together with the new steel cable holder, the newly designed cable mount with integrated door guide keeps the steel cables running smoothly in the angular frame without them touching the sections.

## 3 Integrated belt fastening

The newly designed moulded end piece contains an integrated fastener for the NovoPort® belt. The maintenance-free belt is fastened securely in the holder.

## 4 Multiple extension spring assemblies

The extension spring garage doors are equipped with sturdy multiple extension spring assemblies. The springs are adjusted at the top end of the assembly. The vertical extension springs require less installation depth and open up new possibilities when space is confined.

## 5 NovoPort® - unique and flexible

The NovoPort® operator system not only offers maximum convenience during operation, but also during installation. After all, the motor is not fixed to the ceiling like conventional operators, but simply integrated into the side garage door track - either on the left or the right depending on the structural conditions. Therefore no ceiling assembly is required.

## 6 Anti-pinch inside and out

The special design of the sections and hinges prevents pinching on the door leaf from the outset.

## 7 Interference protection and cables channelled down the inside

The angular frames make it almost impossible to reach between the door leaf and the frame. Suspension cables arranged inside minimize the risk of injury and guarantee maximum operational reliability.

## PLUS The advantages at a glance

- Easy to install; low installation height
- The spring is easy to adjust
- The horizontal tracks are shorter (and require less space)
- NovoPort® is easy and fast to install
- Lower standard headroom requirement
- Added to which, the vertical extension spring system on iso 45 sectional garage doors is cheaper than the torsion spring version

### Torsion springs for iso 45

For a modest surcharge, our high-quality iso 45 sectional garage doors (up to 3,000 x 2,750 mm [WxH])\* can be supplied with torsion springs with maintenance-free spring fracture safety device that is tested to EN 12604. All larger versions are standard equipped with our sturdy torsion springs, thus ensuring that the garage door is held firmly and can be pushed up, even if a spring breaks.



\* For models with Woodgrain finish. The size restriction for models with smooth surfaces is max. 3,000 x 2,500 mm.

EXCELLENT ENERGY  
SAVING PROPERTIES

Standby  
**0.5**  
watt



WITH LED



# PLUS

## The advantages at a glance

- The operating element is fitted with modern and energy-saving LED lighting that shines 13 times brighter than a conventional bulb of identical wattage.
- The lighting (1.6 W), which is now integrated in the control unit, switches on automatically when the garage is opened; the lighting duration can be programmed from 1 to 4 minutes.
- The remote control unit has automatic signal encryption to ensure the utmost protection against manipulation. The receiver lies protected in the operator housing.
- Quick and easy operation via a 2-channel rolling code hand transmitter. Apart from the hand transmitter, the operator can also be operated via a push button, key switch or coded key pad, which are mounted on the garage wall. Radio controlled, not a wire anywhere. That saves costs!
- Soft start and stop function.
- An integrated fault diagnosis system facilitates potential service work.
- Air vent setting for garage ventilation.

Five-year manufacturer's warranty on all mechanical, motor and motor control components.



## Exclusive ease of use: The NovoPort® system

If you are renovating your garage, you don't just want it to look better, but to also open more easily and save electricity. With the combined NovoPort® system consisting of garage door, operator and hand transmitter, you can raise the level of comfort in your garage at the push of a button and also shut out any inconveniences. You'll never have to get out in the rain or cold and open and close the garage door by hand! Garage door and operator are perfectly matched to one another and certified by independent institutes in accordance with the latest safety guidelines. So you can rest assured that you are not just making life easier: you are also maximizing security.

With a 5 year warranty on all the mechanical, motor and motor control components included!

# NovoPort®



## Menu-guided programming

Programming is convenient and easy with three buttons and a clear 7-segment display. You are guided systematically through the menu to ensure that no settings are overlooked while programming. All settings are infinitely saved, even in case of a power cut. The operating state is always visible. Clear error coding allows for quick and safe troubleshooting if required.



## Wall switches

A push button for opening the garage from the inside is directly integrated into the control unit and does not have to be purchased and mounted separately as an accessory.



## New LED lighting

In addition to the new, integrated LED lighting (1.6 W), the NovoPort® also has easily accessible connections for wired accessories, such as external lights or signal lamps controlled by hand transmitter or switch.

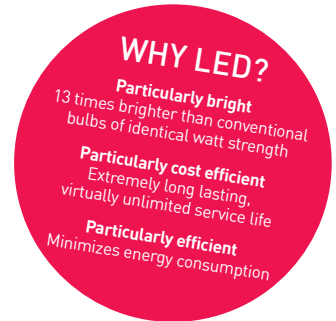

## Belt

The belt is embedded in the garage door track, maintenance-free and protected.

## Assembly advantages



- 1 No additional operator track**  
The NovoPort® operator is directly integrated into the side garage door track. This saves on the cost of materials, installation and maintenance.
- 2 No extra space required**  
Operator requires no extra space above the garage door so you can use the space for storage purposes. No on-site related installation problems.
- 3 No lowering of the ceiling or drive unit**  
Special lowering constructions often have to be manufactured in case of high garage ceilings in order to be able to mount the operator. This is not necessary with the NovoPort® system.
- 4 No ceiling assembly**  
No installation problems in the ceiling area: lighting, beams or drainpipes do not have to be dismantled or bypassed. No difficult drilling into reinforced concrete ceilings, no use of special wall plugs in gypsum plasterboards, no danger of through drilling with thin ceilings, no dirt from operator components through bore dust.
- 5 No increased insertion depth**  
Track-guided operators protrude approx. 30–40 cm outwards beyond the garage door and often have to be shortened on the building site. NovoPort® fits straight away!

# Door patterns

For single garages

For double garages up to 5.50 m in width



Horizontal rib

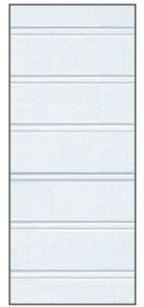
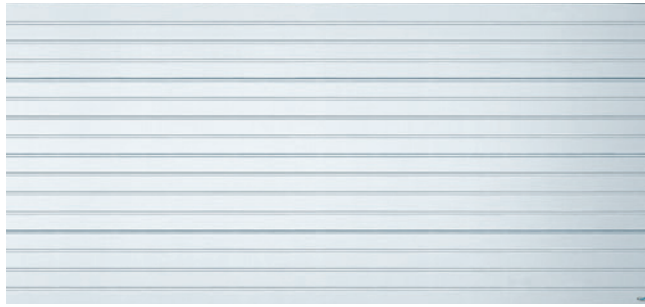

Large rib

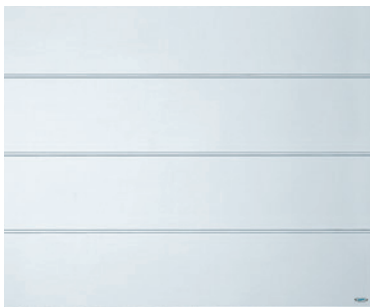
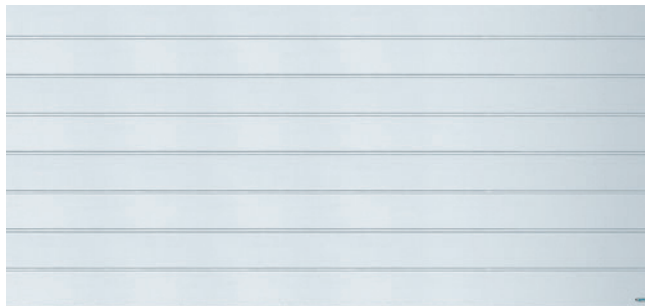

Flush

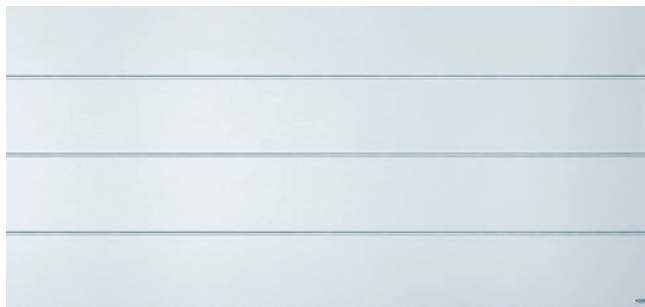

Microline (Flush)

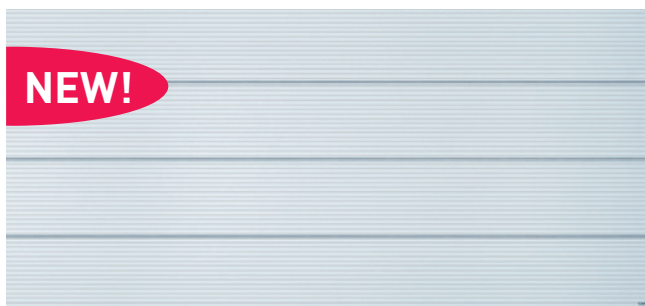

Raised panel finish

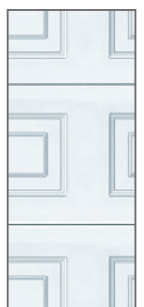

Illustrations show garage leaf door size 2,500 x 2,125 mm for single garages and garage leaf door size 4,500 x 2,125 mm for double garages. Other garage door sizes can deviate from the illustration shown.



# Surfaces, structures and colours

## Experience more colour and enhanced individualism

Our iso 20 and iso 45 sectional garage doors are available on request in a subtly grained Woodgrain wood structure or in the elegant smooth surface Noblesse, which simply repels dust and moisture. For further individualisation, you can choose from 11 top-coated, attractively priced Super-Color colours/ preferred colours and nearly all RAL colours (iso 45).



Woodgrain



Noblesse (smooth) (depending on the pattern)

## Super-Color colours/ preferred colours



Steel blue,  
similar to RAL 5011



Moss green,  
similar to RAL 6005



Fir green,  
similar to RAL 6009



Light grey,  
similar to RAL 7035



Window grey,  
similar to RAL 7040



White aluminium,  
similar to RAL 9006



Grey aluminium,  
similar to RAL 9007



Anthracite,  
similar to RAL 7016



Ochre brown,  
similar to RAL 8001



Nut brown,  
similar to RAL 8011



Sepia brown,  
similar to RAL 8014

## RAL colours for iso 45



You want more?  
Pass doors can also be supplied in the RAL colour of your choice for a small additional charge.

## Rustic wood effects



Golden oak (smooth)

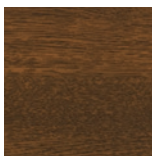

Dark oak (smooth)



Mahogany (smooth)

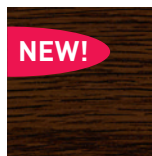

Black oak (smooth)

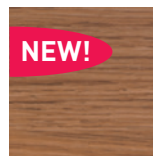

Winchester (smooth)

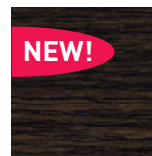

Moor oak (smooth)

Our iso 45 sectional garage doors are available with six different weather-resistant, top-coated film laminates in authentic, rustic wood effects with a smooth surface. In addition to the large rib pattern, you can now also order all the wood effects in the flush and some in the panel pattern (not Winchester, Black oak and Moor oak).

## Benefit from our new structural surfaces!



Satin white,  
similar to RAL 9016

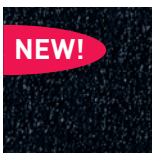

Satin Dark grey,  
similar to RAL 7016

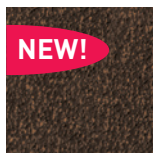

Satin brown,  
similar to RAL 8014



Satin grey  
[composite shade]

In addition to the existing Satin grey, our iso 45 sectional garage doors are now available in three more decorative, top-coated satin matt structural surfaces with reduced dirt retention and exceptional weather resistance.

## New Microline pattern (Flush) in Satin white and Satin grey



Microline (Flush)  
Satin white,  
similar to RAL 9016



Microline (Flush)  
Satin grey  
[composite shade]

Exclusively for the flush pattern for iso 45 sectional garage doors, our popular industrial door profiled finish Microline (Flush) is available in Satin grey and Satin white. This is a modern, profiled wave structure with a striking and expressive light and shade effect.

# Pass doors



## Perfectly integrated: Pass doors with matching design

If your garage is too narrow for a side door, but you don't want to have to do without that convenience, then we recommend an integrated pass door. Pass doors are available for all iso 45 exclusive garage doors up to a width of 5 m. They offer a practical passage width of 85 cm (raised panel designs: 60 cm) and are fitted with double-skinned insulation to ensure perfect heat insulation.

Pass doors are arranged centrally or asymmetrically depending on the garage door width



Symmetrical arrangement for garage door widths up to 3.50 m

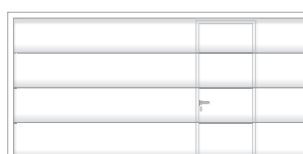

Asymmetrical arrangement for garage door widths above 3.50 m – either left or right

## Pass door panels with and without glazing



Horizontal rib



Large rib



Flush



Raised panel finish

Pass doors are available for exclusive garage doors in the patterns shown on the left. Glazing variants for all garage door patterns: standard windows, crossbar windows, light strip or rhombus windows. Illustrations show garage door leaf size 2,500 x 2,125 mm. Other garage door sizes can deviate from the illustration shown.



Glazing variants  
Standard window



Glazing variants  
Crossbar window



Glazing variants  
Light strip



Glazing variants  
Rhombus window



## The door sill area

The robust garage door leaf frame ensures that the garage door cannot be bent even when opened. The anodized aluminium sill is only 24 mm high.



## Door closes automatically

The standard door closer is responsible for automatic closing. This is especially practical when you've got your hands full, e.g. if you are taking your bicycle, moped or lawn mower out of the garage. A hold-open mechanism (at 90°) is available for a small additional charge.



## Softline profiles

Softline profiles (rounded) and concealed hinges ensure an aesthetic overall appearance of the garage door. The frame of the leaf is standard painted in traffic white, similar to RAL 9016. It can be varnished in the same colour as the door leaf using any other RAL colour. In the case of coated door leaves (wood shades, Satin grey, Satin white, Satin Dark grey and Satin brown), the door leaf frame is varnished in a matching shade for a surcharge.



## Secure multiple locking mechanism

Protect yourself and your property. A multiple locking mechanism on the pass door is highly recommended if your garage offers direct access to the house, or is used as a hobby room or to store an expensive mountain bike. This mechanism locks each of the pass door sections individually and can be centrally activated from both inside and out using the profile cylinder lock.

## Available colours and surfaces

### Surfaces



Woodgrain

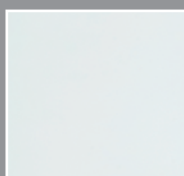

Noblesse (smooth)

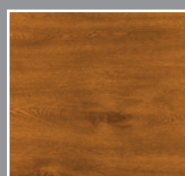

Golden oak (smooth)

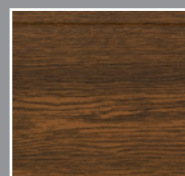

Dark oak (smooth)

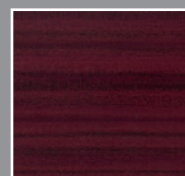

Mahogany (smooth)

### Satin (structural surfaces)



Satin white, similar to RAL 9016



Satin grey (composite shade)

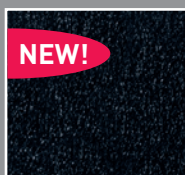

Satin Dark grey, similar to RAL 7016

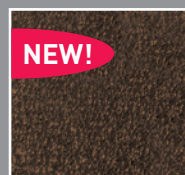

Satin brown, similar to RAL 8014

### RAL-Farben



You want more? Pass doors can also be supplied in the RAL colour of your choice for a small additional charge.

For further individualisation, you can choose from 11 top-coated, attractively priced Super-Color colours/ preferred colours (see garage door finder on page 14). Note: With film-covered colour shades and structural surfaces, the pass door frame profiles are produced in a suitably toning shade.

# Side doors



## Letting life into the house

Don't want to always have to raise and lower the door for your bike, lawn mower or screwdriver? Then Novoferm has the practical solution for you: we offer matching side doors with all sectional garage doors – for going in and out in no time and for an all-round harmonious appearance, too. And the processing is something to be proud of as well: All of our side doors are made of high-quality aluminium profiles. The door leaves are filled with double-skinned, hot galvanized sheet steel with a core of rigid PUR foam.

### Patterns for 1-leaf side doors, garage door type iso 20/ iso 45



1. **Horizontal rib**  
Traffic white,  
similar to RAL 9016



2. **Large rib**  
Traffic white,  
similar to RAL 9016



3. **Flush**  
Traffic white,  
similar to RAL 9016



4. **Microline (Flush)**  
(only iso 45)  
Satin white,  
similar to RAL 9016



5. **Raised panel**  
(only iso 45)  
traffic white,  
similar to RAL 9016



6. **Flush**  
Moss green,  
similar to RAL 6005



7. **Flush**  
Golden oak  
(only iso 45)



8. **Large rib**  
Satin Dark grey,  
similar to RAL 7016  
(only iso 45)

Precise  
processing -  
reliable  
operation



Triple lock  
(optional)

Novoferm side doors are available in a wide range of door patterns, surfaces and colours. They are supplied as standard with a black rounded handle set and security lock.  
Note: With film-covered colour shades and structural surfaces, the aluminium profiles of the side doors are produced in a suitably toning shade.

# DuoPort



## The solution for more scope

In addition to providing high insulation values, our insulated Duo-Port leaf doors offer you the possibility to use your garage as a utility room, for leisure time or hobbies. You can choose whether to open both door leaves or only the active leaf, depending on your particular requirements. The use of high-quality and durable materials, top-quality processing and a wide variety of additional fittings give your garage a classic appearance in keeping with the style of your house and your personal taste.

### Patterns for 2-leaf side doors, garage door type iso 45

All door leaf frames are made of aluminium and guarantee maximum weather resistance, while robust hinges provide long-term, dimensionally accurate opening and closing.



Hinge lock (optional)



**1. Horizontal rib**  
Traffic white, similar to RAL 9016



**2. Large rib**  
Traffic white, similar to RAL 9016



**3. Flush**  
Traffic white, similar to RAL 9016



**4. Microline (Flush)**  
Satin white, similar to RAL 9016



**5. Raised panel**  
Traffic white, similar to RAL 9016

Note: With film-covered colour shades and structural surfaces, the aluminium profiles of the 2-leaf side doors are produced in a suitably toning shade.

## Garage door facts

- For private garages up to 3 m in width
- Smooth running and stable, with double-skinned, galvanized steel sections
- High degree of safety with anti-pinch feature inside and out (according to EN 12604) as well as interference-protected triple safety extension spring assemblies
- Good heat insulation with 20 mm rigid PUR foam core (heat insulation value  $K = 1.0 \text{ W/m}^2\text{K}$ )
- Inside door leaf: polyester-based base coat, grey white, similar to RAL 9002
- Outside door leaf, standard: traffic white, similar to RAL 9016 (base coat)
- Door leaf outside: Super-Color colour/ preferred colour for an additional charge (top-coated)

**NEW!**

Our iso 20 sectional garage doors with a vertical extension spring system are fitted with multiple safety extension spring assemblies.



## Insulation thickness



Iso 20 is filled with a 20-mm rigid foam core, which provides good heat and sound insulation.

### Surfaces for iso 20



**Woodgrain**  
(only for horizontal rib and large rib garage door patterns)

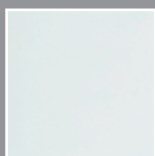

**Noblesse (smooth)**  
(only for flush garage door pattern)

### Standard colour



**Traffic white,**  
similar to RAL 9016

### Super-Color colours/ preferred colours



**Steel blue,**  
similar to RAL 5011



**Moss green,**  
similar to RAL 6005



**Fir green,**  
similar to RAL 6009



**Light grey,**  
similar to RAL 7035

## Door patterns

## Side doors



Horizontal rib



Large rib

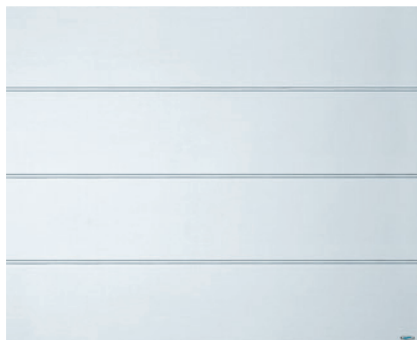

Flush

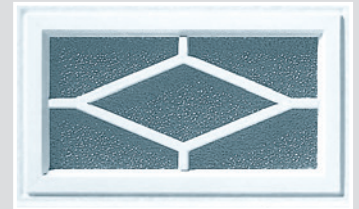

Illustration shows garage door leaf size 2,500 x 2,125 mm.  
Other garage door sizes can deviate from the illustration shown.

## Windows



Variant 1: Standard window



Variant 2: Elegant rhombus pattern

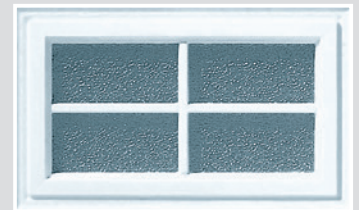

Variant 3: Classic cross bar window

Dimensions:  
inside: approx. 392 x 192 mm  
outside: approx. 460 x 260 mm

Window thickness:

- Large rib pattern: 16 mm double acrylic glazing, transparent or crystal

## Handles



Plastic handle, black (optional)

You can find additional handles on page 18.

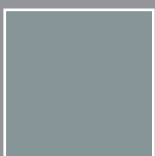

Window grey,  
similar to RAL 7040



White aluminium,  
similar to RAL 9006



Grey aluminium,  
similar to RAL 9007



Anthracite,  
similar to RAL 7016



Ochre brown,  
similar to RAL 8001



Nut brown,  
similar to RAL 8011

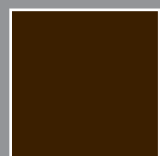

Sepia brown,  
similar to RAL 8014

## Garage door facts

- Suitable for private garages with a width of between 2,250 and 5,500 mm
- Widest range of models and equipment:
  - individual design garage door
  - with side door or integrated pass door of the same design
- Smooth running, superbly durable and stable thanks to a sturdy design that is extremely distortion-resistant
- Spring technology either with a vertical extension spring system or with stable torsion spring shafts
- Perfect functional reliability and easy operation with torsion spring with spring break safety feature on both sides
- Maximum personal safety with anti-pinch feature inside and out (according to EN 12604)
- Maximum heat insulation with 45 mm rigid PUR foam core (heat insulation value  $K = 0.5 \text{ W/ m}^2\text{K}$ )
- Inside door leaf: polyester-based base coat, grey white, similar to RAL 9002
- Outside door leaf, standard: traffic white, similar to RAL 9016 (base coat)
- Outside door leaf: Super-Color or RAL of choice at additional cost (top-coated)

**NEW!**  
EXTENSION SPRING  
TECHNOLOGY TO  
YOUR CHOICE

Our iso 45 sectional garage doors are available with either a vertical extension spring system or stable torsion springs (depending on size) with a maintenance-free spring fracture safety device tested to DIN EN 12604.

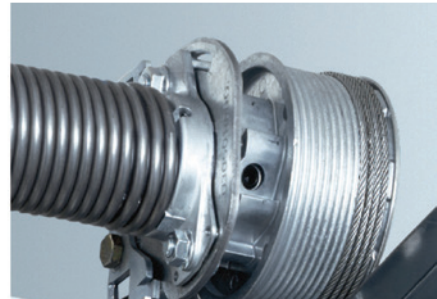

## Insulation thickness

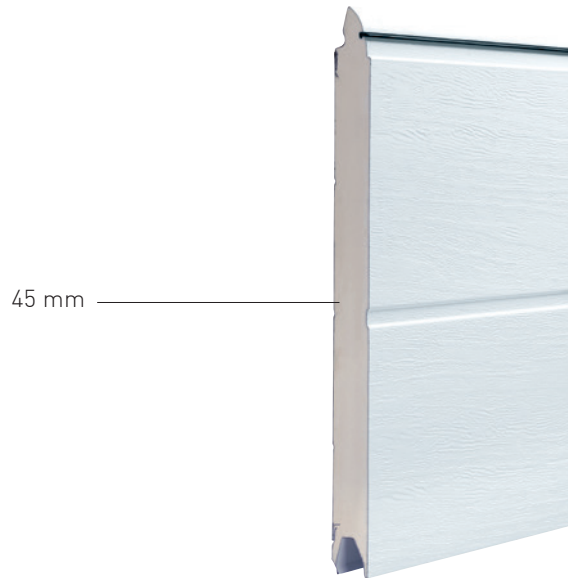

Iso 45 is filled with a 45-mm rigid foam core, which provides max. heat insulation and top soundproofing values.

## Surfaces for iso 45



**Woodgrain**  
The robust classic design with a subtly grained wood structure.

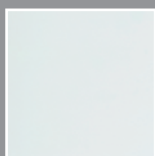

**Noblesse (smooth)**  
The elegant smooth surface which simply repels dust and moisture.

## Standard colour



**Traffic white,**  
similar to RAL 9016

## Super-Color colours/ preferred colours



**Steel blue,**  
similar to RAL 5011



**Moss green,**  
similar to RAL 6005



**Fir green,**  
similar to RAL 6009



**Light grey,**  
similar to RAL 7035



## Door patterns

## Side doors 1-leaf

## Pass doors



Horizontal rib

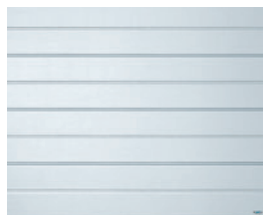

Large rib

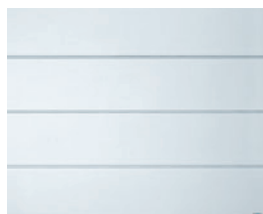

Flush



Microline (Flush)\*



Raised panel



Illustrations show garage door leaf size 2,500 x 2,125 mm. Other garage door sizes can deviate from the illustration shown.

\* Available only in the structured surfaces listed for Microline.

Illustrations show garage door leaf size 2,500 x 2,125 mm. Other garage door sizes can deviate from the illustration shown.

## Wood effects (smooth)

The weather-resistant foil coating with authentic rustic wood effects.

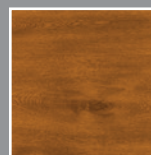

Golden oak

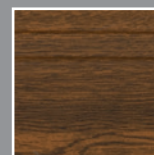

Dark oak

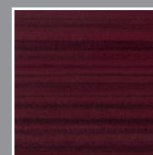

Mahogany

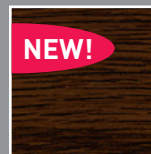

Black oak



Winchester

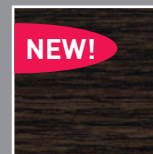

Moorest oak

## Satin (structural surfaces)

Extremely weather-resistant and dent reversible top coating, only for iso 45 garage doors.



Satin white, similar to RAL 9016



Satin Dark grey, similar to RAL 7016



Satin brown, similar to RAL 8014

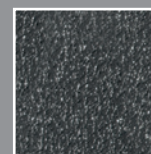

Satin grey (composite shade)

## Microline (Flush)\*

The popular and expressive industrial door profiled finish is now also available for private homes.



Satin white, similar to RAL 9016

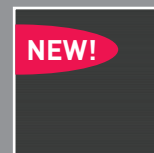

Satin grey (composite shade)

\* Available only in the structured surfaces listed for Microline.

## RAL colours (top coated)



Super-Color and RAL colours are available at a small additional charge.



Window grey, similar to RAL 7040



White aluminium, similar to RAL 9006



Grey aluminium, similar to RAL 9007

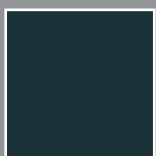

Anthracite, similar to RAL 7016



Ochre brown, similar to RAL 8001



Nut brown, similar to RAL 8011

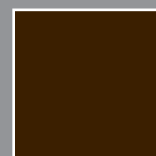

Sepia brown, similar to RAL 8014

## Additional accessories for iso 45

### Handles



Door handle, plasticcoated, in Super Color or RAL colour



Aluminium silver colour anodized



Aluminium new-silver colour anodized



Aluminium brass colour anodized



Aluminium with rustic structured effect



Aluminium, PVC-coated, traffic white



Matching door handles are available in all 11 Super-Colors and numerous RAL shades.

### Windows



Standard window



Cross bar pattern



Rhombus pattern



Sunrise pattern

Dimensions: inside: approx. 392 x 192 mm  
outside: approx. 460 x 260 mm

Window thicknesses:

- Horizontal rib, large rib and flush: 25 mm acrylic double glazing, transparent or crystal.
- Raised panel pattern: 20 mm double acrylic glazing, transparent or crystal.

### Window cutouts



Rectangular, wide, with transparent double acrylic glazing\*

Dimensions: inside: approx. 651 x 251 mm  
outside: approx. 726 x 326 mm



Rectangular, narrow, with transparent double acrylic glazing\*

Dimensions: inside: approx. 568 x 135 mm  
outside: approx. 638 x 205 mm



Porthole with stainless steel frame, with 10-mm double acrylic glazing\*\*

Dimensions: inside: approx.  $\varnothing$  290 mm  
outside: approx.  $\varnothing$  350 mm

\*Only for horizontal rib, large rib and flush garage door patterns.

\*\*Only for large rib and flush garage door patterns.

### Light strip



Pane thickness 16 mm



Acrylic glass with crystal structure



Double pane acrylic glass



Polycarbonate cross bar double plate

The light strip is also available in expanded grating format with PVC coating.

Note: With film-covered colour shades and structural surfaces, all windows are produced in a suitably toning shade.

## Accessories

### Hand transmitters

**NEW!**



**Mini-Novotron 522 Design hand transmitter**  
2-channel, 433 MHz,  
KeeLoq rolling code

**NEW!**



**Mini-Novotron 524 Design hand transmitter**  
4-channel, 433 MHz,  
KeeLoq rolling code

**NEW!**



**Mini-Novotron 522 hand transmitter**  
2-channel, 433 MHz,  
KeeLoq rolling code

**NEW!**



**Mini-Novotron 524 hand transmitter**  
4-channel, 433 MHz,  
KeeLoq rolling code



**Mini-Novotron 502 hand transmitter**  
2-channel, 433 MHz,  
KeeLoq rolling code



**Mini-Novotron 504 hand transmitter**  
4-channel, 433 MHz,  
KeeLoq rolling code



**Mini-Novotron 504 hand transmitter**  
4-channel, 433 MHz,  
KeeLoq rolling code



**Micro-Novotron 512 hand transmitter Design**  
2-channel, 433 MHz,  
KeeLoq rolling code

### Wall mounting

**NEW!**



**Wall mounting/ silicon case**  
Suitable for use as case and wall  
mounting for Mini-Novotron 522  
Design/ 524 Design and for  
Mini-Novotron 522/ 524

### Remote switches

**NEW!**



**Signal 111 remote wall switch**  
2-channel, 433 MHz, KeeLoq rolling  
code for controlling 2 operators or  
1 operator and 1 outside lighting  
in UV-resistant material

**NEW!**



**Signal 218 remote coded key pad**  
10 codes, 433 MHz, KeeLoq rolling  
code with stainless steel cover, backlit  
in UV-resistant material

### Switches

**NEW!**



**Signal 112 wall switch**  
Start key, holiday switch,  
continuous light (on/ off),  
24 V connection to the operator  
in UV-resistant material



**Coded key pad signal 213**  
3 signals, metal key pad,  
230 V connection

### Opto sensors



**Extra 625 one-way opto sensor**  
• 24 V DC, IP 54  
• Range: 8 m  
• Suitable for: all operator models



**Extra 626 one-way opto sensor**  
• 20-28 V, IP 50, 2 wire  
• Range: 8 m  
• Suitable for:  
Novomatic 423/ 563 S  
NovoPort®



**Extra 628 reflection light opto sensor**  
• 24-240 V AC, 12-240 V DC, IP 54  
• Range: 5 m  
• Can only be used as a pulse generator



**Extra 315 emergency unlocking**  
• With safety profile half cylinder

All our new and existing hand transmitters are compatible with all our new and existing operators.  
Ask your dealer to show you our full range of accessories.

# Novoferm E® sectional garage door

## Installation dimensions for sectional garage doors

### Required installation dimensions

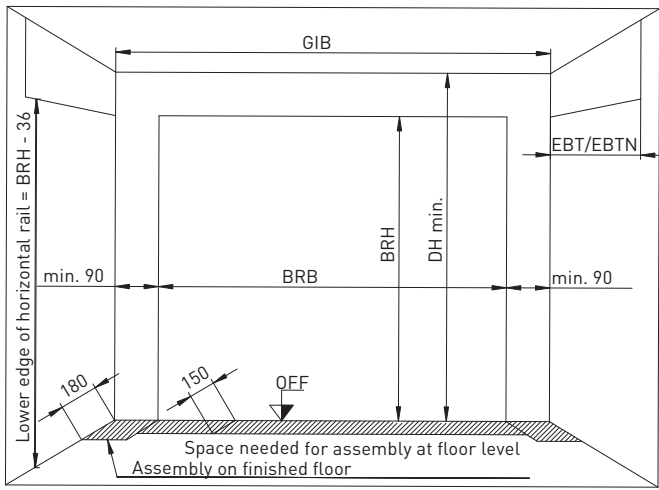

- BRB = Coordinating width (order size)
- BRH = Coordinating height (order size)
- DH = Ceiling height (minimum dimension)
- GIB = Interior garage width (minimum dimension)
- EBT = Installation depth of the door
- EBTN = Installation depth of garage door with Novomatic operators
- RAMB = Outer frame width
- RAMH = Outer frame height
- OFF = Upper-edge finished floor
- LDH = Clear passage height

Please consult the "Coordinating widths and heights" chart or calculate the dimensions based on the drawings.

If the structure does not have the required minimum dimensions, it can be compensated by fitting panels and profiles.

All dimensions in mm.

## Installation dimensions for iso 20 sectional doors

### Vertical section through garage door

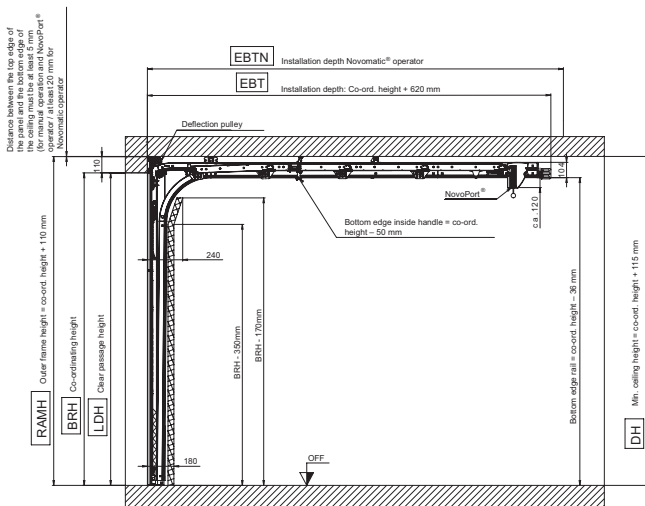

All dimensions in mm.

### Horizontal section through garage door

#### Angular frame

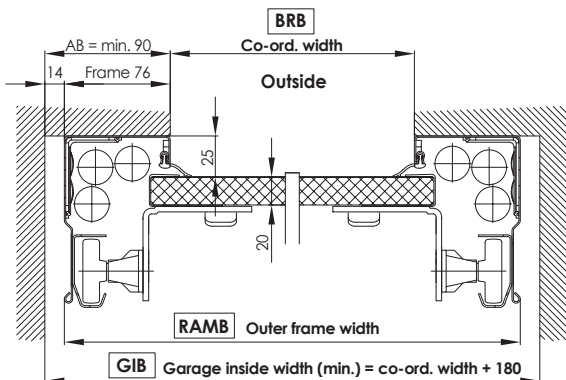

All dimensions in mm.

# Novoferm E<sup>®</sup> sectional garage door

## Installation dimensions for iso 45 sectional doors

### Vertical section of extension spring arrangement

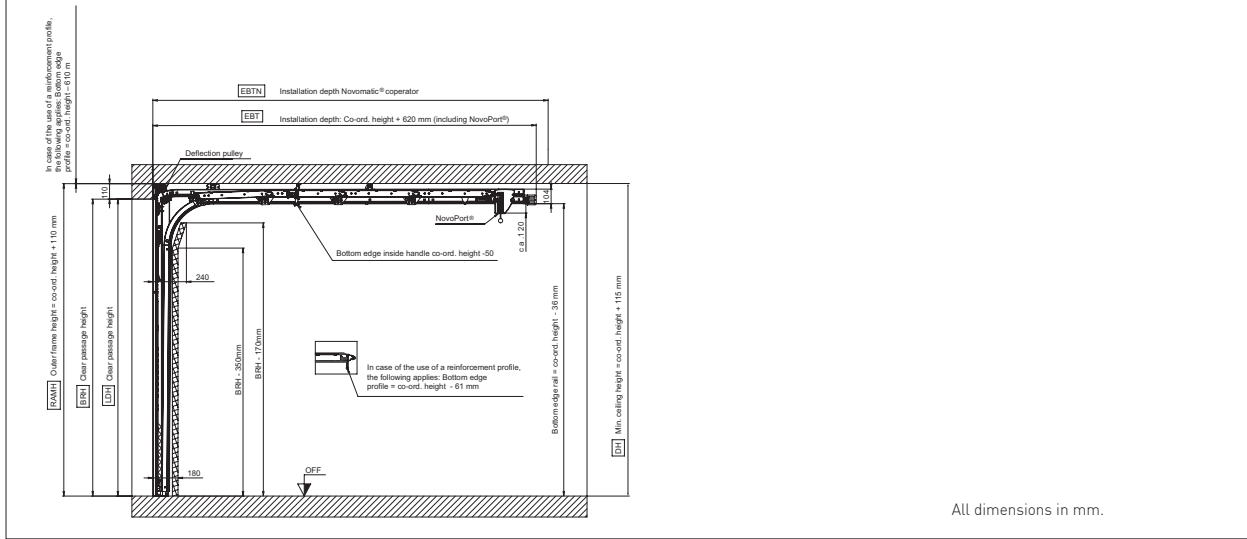

### Vertical section of front-mounted torsion spring (VL)

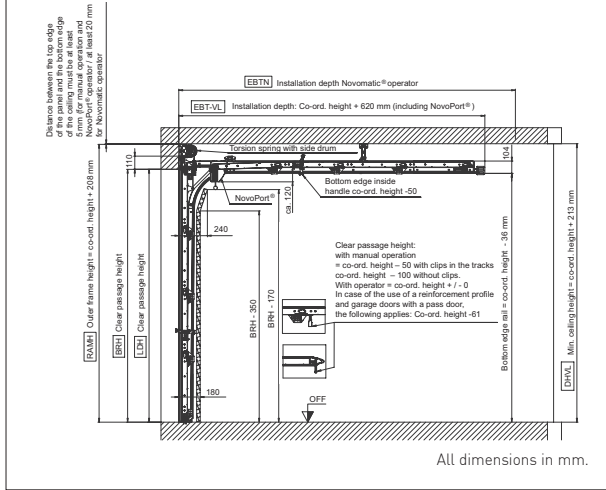

### Vertical section of rear-mounted torsion spring (HL)

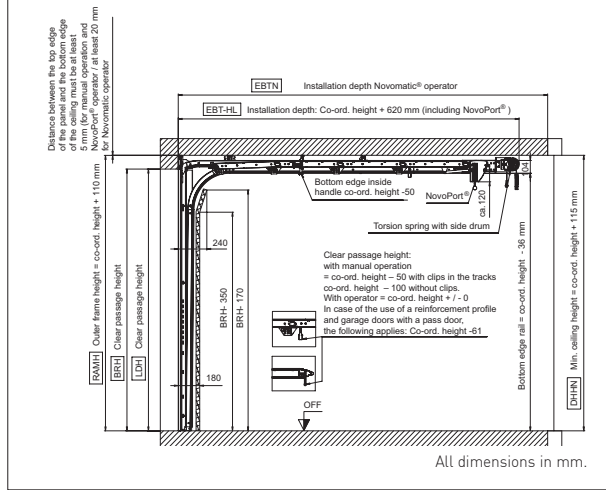

### Horizontal section through garage door with a torsion shaft

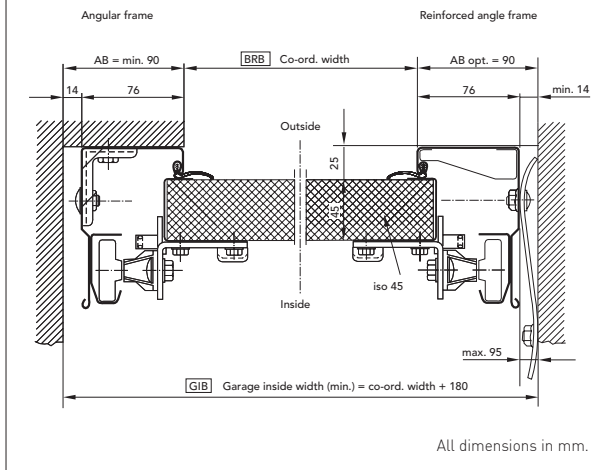

### Horizontal section through garage door with vertical extension spring arrangement

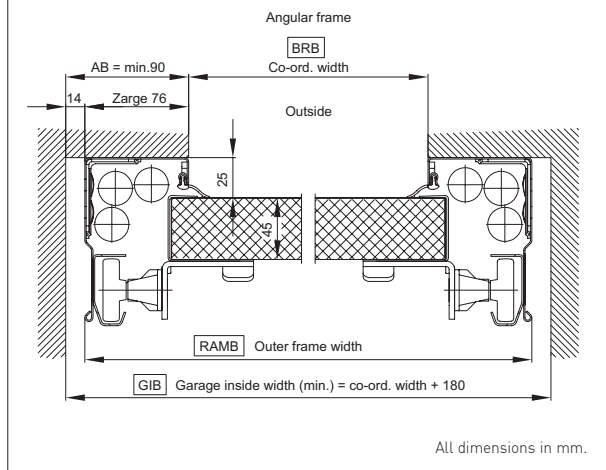

# Novoferm E® side doors

## Installation dimensions for side doors

### Block frame (opens inwards or outwards)

Horizontal section/ Installation behind the opening

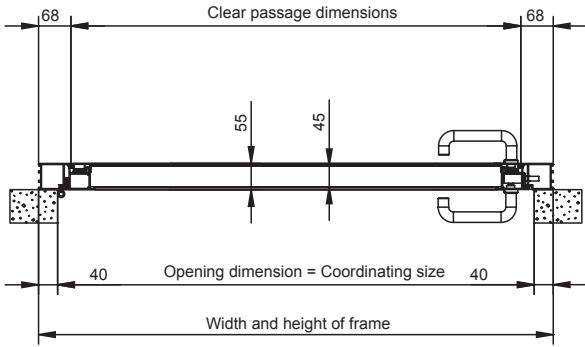

Horizontal section/ Installation in the opening

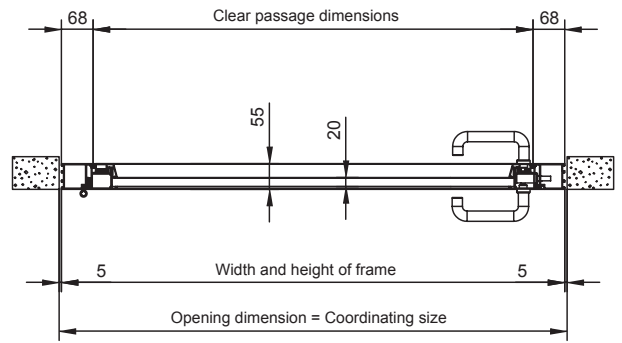

Vertical section/ Installation behind the opening

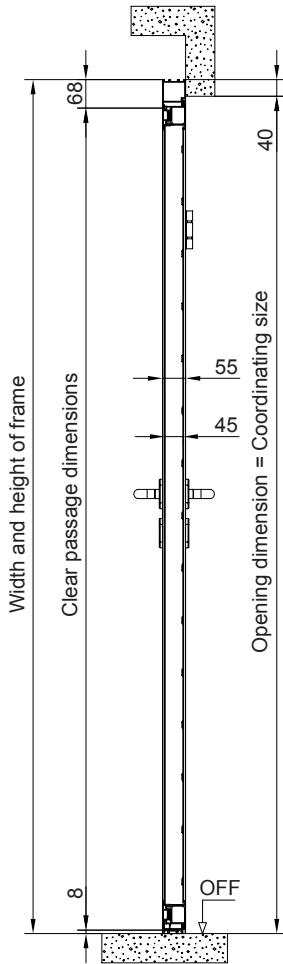

Vertical section/ Installation in the opening

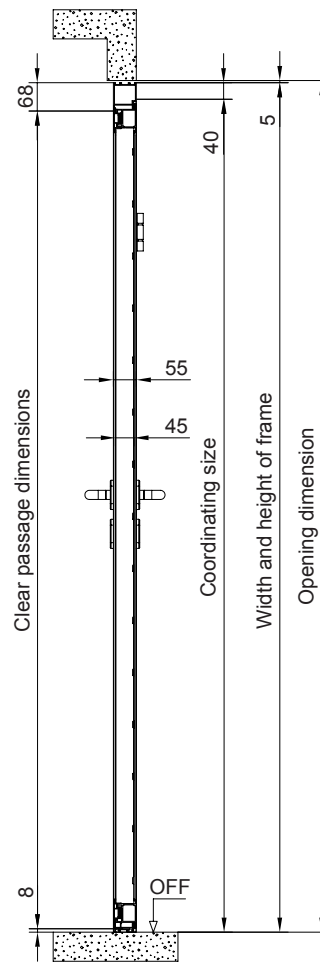

All dimensions in mm.

Side door design matched to iso 45



## **Novoferm. On-site. Direct. Europe-wide.**

Novoferm Group is one of Europe's leading system suppliers of doors, garage doors, frames and operators. We offer a large range of products and services for private, commercial and industrial applications. All our products are manufactured to the highest quality standards and reflect best engineering practice. We combine maximum functionality with innovative design. We manufacture our products in various international locations and with our Europe-wide network we are always available to help you – wherever you are!

Your Novoferm sales partner



Novoferm GmbH  
Schüttensteiner Str. 26  
D-46419 Isselburg  
Tel.: (0 28 50) 9 10-0  
Fax: (0 28 50) 9 10-650  
E-Mail: [sales@novoferm.com](mailto:sales@novoferm.com)  
[www.novoferm.com](http://www.novoferm.com)

